



هيئة تنظيم الاتصالات  
Telecommunications Regulatory Authority

## **Access Order No. 1 of 2009**

### **An Access Order Relating Local Loop Unbundling, Bitstream and Wholesale DSL issued pursuant to the Access Regulation**

14 September 2009

Reference: MCD/09/09/065

*in this document [•] indicates information removed due to confidentiality*

**Purpose:** To impose Access Obligations upon Bahrain Telecommunications Company B.S.C to unbundle the local loop and to continue to provide Bitstream and Wholesale DSL as part of its Wholesale Reference Access Offer under the Access Regulation and pursuant to Section 57 (e) of the Telecommunications Law.

## TABLE OF CONTENTS

ACCESS ORDER .....	2
ANNEX A: IMPLEMENTATION .....	4
ANNEX B: IMPLEMENTATION REPORT .....	13
ANNEX C: STUDY ON THE REGULATION OF WHOLESALE BROADBAND MARKETS ...	95
ANNEX D: LEGAL REASONING .....	153

## ACCESS ORDER

Pursuant to:

1. the exercise of its powers under articles 3(c)1, 3(c)13, 40 and Article 57 of Legislative Decree No.48 of 2002, the Telecommunications Law<sup>1</sup>, and articles 2, 3, 5, 6 and 8 of the Access Regulation issued on 30 April 2005 (“Access Regulation”);
2. the Dominance Determination in Wholesale Broadband Markets issued by Telecommunications Regulatory Authority (“TRA”) on 14 September 2009;
3. the Implementation Report for Local Loop Unbundling in the Kingdom of Bahrain (“the Implementation Report”) (attached to this Access Order as **Annex B**),
4. the Study on the Regulation of Wholesale Broadband Markets (“the Study”) (attached to this Access Order as **Annex C**).

TRA hereby orders Batelco to perform the following:

### 1. PROVISION OF ACCESS SERVICES

- 1.1 Implement and offer full local loop unbundling (“LLU”) by offering a dedicated point-to-point metallic path facility (the copper local loop), providing physical connectivity between Batelco’s Main Distribution Frame in Batelco’s Service Nodes and Batelco’s Network Termination Points at End Users’ premises, as described in the Implementation Report.
- 1.2 Provide related ancillary services described in this Access Order and its Annexes.
- 1.3 Continue to provide Bitstream and Wholesale DSL as part of the Batelco’s Reference Offer, subject to the provisions of paragraph 4.2 of this Access Order.
- 1.4 Batelco must implement this Access Order in accordance with Annex A (Implementation). Annex B (Implementation Report) provides the supporting rationale.
- 1.5 For the avoidance of doubt the Annexes to this Access Order form an integral part of it.

### 2. SCOPE OF THE ACCESS ORDER

- 2.1 This Access Order applies only to Batelco’s metallic path (copper local loop) and applies to both active and non-active lines for which there is capacity available at both the main and distribution network levels.

### 3. ENTRY INTO FORCE AND EFFECT OF THIS ORDER

- 3.1 This Access Order and related Access Obligations will be effective upon the date of signature of the General Director.

---

<sup>1</sup> Published in the Official Gazette of the Kingdom of Bahrain Annex to Issue No. 2553, Wednesday, 17 Sha’aban 1423 (h) - (23 October, 2002).

**An Access Order Relating Local Loop Unbundling, Bitstream  
and Wholesale DSL issued pursuant to the Access Regulation**

- 3.2 This Access Order is without prejudice to any further orders, regulations and determinations that TRA may consider necessary pursuant to its powers and duties, including but not limited to:
- (a) Articles 3(c)(1), 3(c)(13) and 3(c)(14) of the Telecommunications Law with respect to the provision of Access;
  - (b) Article 5 of the Access Regulation with respect to TRA's powers to review Reference Offers;
  - (c) Articles 35 and 65 of the Telecommunications Law; and
  - (d) Article 8.1 and 8.2 of the Access Regulation with respect to the enforcement of the Access Regulation.

**4. COMPLIANCE**

- 4.1 Batelco shall comply with the provision of the Access Order and Annexes as long as it is determined, by TRA, to be a Dominant Operator in the Wholesale Physical Network Infrastructure Access Market and in the Wholesale Market for Broadband Access in accordance with the Dominance Determination issued on *14 September 2009*, and as may be updated by TRA from time-to-time.
- 4.2 Within 12 months from the date of issuance of this Order, TRA shall commence a study to determine whether the Bitstream service is "fit for purpose". "fit for purpose" is to be assessed in terms of material compliance with the service description and process implementation and through an analysis of the market impact of the Bitstream service. Should TRA determine that the Bitstream service is "fit for purpose" TRA shall remove the obligation on Batelco to provide Wholesale DSL no sooner than 6 months from the issuance of that determination. That determination may also include specific provisions for the migration of other licensed operators ("OLOs") End Users that are being provided services on a Wholesale DSL to an appropriate replacement service (if needed) or other migration terms.

Signed on **14 September 2009**

**Alan Horne**

General Director

Telecommunications Regulatory Authority, Manama, Kingdom of Bahrain



**An Access Order Relating Local Loop Unbundling, Bitstream  
and Wholesale DSL issued pursuant to the Access Regulation**

**Annex A**

**Implementation**

**An Access Order Relating Local Loop Unbundling, Bitstream  
and Wholesale DSL issued pursuant to the Access Regulation**

## 1. IMPLEMENTATION PROCESS

### Reference Access Offer

- 1.1 Article 5.1 of the Access Regulation requires Operators that have been determined dominant in a relevant market to provide TRA with a Reference Offer within 2 months of the date of the dominance determination. Batelco must prepare a meaningful LLU Reference Offer Service Description (“LLU SD”) and submit for TRA’s review, within 2 months of the Dominance Determination.
- 1.2 The LLU SD must contain at a minimum the provisions outlined in Article 4.2 of the Access Regulation. The Implementation Report attached in Annex B (which has been consulted upon with the industry) outlines what TRA expects will be provided by Batelco in its LLU SD, such as SLAs, KPIs and forecasting requirements.

### Implementation Timetable

- 1.3 Batelco must take the following actions as per the timetable below:

<b>Action to be completed by Batelco according to the Access Order</b>	<b>Date of completion</b>
Release an Access Network Frequency Plan to the participating OLOs in the LLU Field Test	No later than 14 days prior to 11 October 2009
Make available the General Information in accordance with paragraphs 3.1 to 3.6 of Annex A	Within 14 days of the date of this Access Order
Provide LLU Process Information to TRA in accordance with paragraph 3.11 of this Annex A	Within 30 days from the date of the Access Order
Make all appropriate preparations in order for the LLU Field Test at the Manama Service Node (MAN) and Seef Service Node (SEF) in accordance with Section 8 of this Annex A	Starting no later than 11 October 2009 and ongoing for a period of 6 weeks
Submit LLU SD for TRA’s review in accordance with paragraphs 1.1 and 1.2 of this Annex A	Within 2 months from the date of the Dominance Determination
Commercial launch of LLU	No later than 14 days from the date TRA approves or orders Batelco’s LLU SD
Implement the Initial Collocation Process if more than 3 operators apply for LLU in accordance with paragraph 4.8 of this Annex A	Within 14 days from the commercial launch of LLU (“Initial Collocation Period”).
Inform TRA whether or not the Initial Collocation process is required.	14 days after the commercial launch of LLU (“Initial Collocation Period”).
Provide LLU Specific Information to OLOs interested in LLU in accordance with paragraphs 3.7 to 3.10	On the date of the commercial launch of LLU
Make available to OLOs a final Access Network	On the date of the commercial

**An Access Order Relating Local Loop Unbundling, Bitstream and Wholesale DSL issued pursuant to the Access Regulation**

Frequency Plan for LLU implementation in accordance with section 5 of this Annex A	launch of LLU
Make ready and available all Ancillary services as defined in Section 4 of this Annex A	On the date of the commercial launch of LLU

**2. SCOPE OF LLU LINES**

- 2.1 Batelco must provide LLU for all active and non-active lines of its copper access network.
- 2.2 The Access Obligation upon Batelco to provide Full LLU extends to Non-Active Lines as explained in the Implementation Report in Annex B of this Access Order.
- 2.3 A Non-Active Line includes all lines that are not presently actively used and would necessitate in order to be actively used no more than the 3 following activities: jumpering at the MDF, jumpering at the street cabinet level or “final drops” installation.
- 2.4 Should an end-user and OLO wish to be connected on a non-active line, then Batelco must allow that line to be unbundled, including if there is no final drop, by installing the final drop, which will be charged by Batelco to the OLO on a time and materials basis.
- 2.5 Batelco may only refuse to unbundle Non-Active Lines based upon objective technical reasons which should be justified in writing to OLOs at the time of Batelco’s refusal.

**3. LLU INFORMATION**

**LLU General Information**

- 3.1 Within 14 days of the date of this Access Order, Batelco must compile and make available, to OLOs, a set of General Information.
- 3.2 The General Information must be provided to OLOs free of charge in either electronic or paper copy at the request of the OLO, and shall contain the following:

**a) The list of MDFs with their category of size in Bahrain, as defined below:**

<b>MDF Size</b>	<b>MDF Name and Site</b>
More than 10,000 working lines	...
Between 7,500 and 10,000 working lines	...
Between 5,000 and 7,500 working lines	...
Between 2,500 and 5,000 working lines	...
Less than 2,500 working lines	...

**b) The address and exchange boundaries of these MDFs on a map (except the ones for which valid national security reasons prevent their location or information being made public).**

**An Access Order Relating Local Loop Unbundling, Bitstream  
and Wholesale DSL issued pursuant to the Access Regulation**

- 3.3 OLOs must request the General Information from Batelco in writing. Batelco must provide the OLO with the General Information no later than 3 days from receipt of the written request.
- 3.4 OLOs requesting General Information do not need to be LLU customers.
- 3.5 The General Information is confidential and cannot be used by the OLO for any purpose other than the analysis and implementation of LLU. The information cannot be provided to any third party unless agreed to by Batelco or if required by law. Should the OLO wish to provide external consultants with the information for the purposes of advising it on LLU analysis and implementation then it must seek Batelco's written permission, which must not be unreasonably withheld. Batelco may insist that the consultant enter into a non-disclosure agreement with the OLO and Batelco.
- 3.6 Batelco may provide the General Information on the condition that the OLO sign a non-disclosure agreement, but which can be no more onerous than the terms outlined in paragraph 3.5 above.

**LLU Specific Information to OLOs that are or indent to be LLU customers**

- 3.7 LLU Specific Information is information that is specific to a particular Service Node as defined in paragraph 4.3 below ("LLU Specific Information").
- 3.8 OLOs requesting LLU Specific Information will need to have signed the Reference Offer Supply Terms with Batelco and should have acquired the appropriate licenses from TRA. OLOs and Batelco will be bound to maintain the confidentiality of the LLU Specific Information in accordance with the confidentiality provisions of the Reference Offer Supply Terms.
- 3.9 OLOs requesting the LLU Specific Information must identify the Service Nodes for which they require LLU Specific Information. The request must be in writing.
- 3.10 Batelco must provide LLU Specific Information to OLOs within 5 working day of receipt of a written request.

**LLU Process Information to TRA**

- 3.11 Batelco must provide to TRA no later than 30 days from the date of the Access Order a list and description of existing internal processes pertaining to the provisioning of lines, together with any associated commitments towards its own end-users, including:
  - a) Documents describing the provisioning processes of lines (if relevant, including documents originating from Batelco's vendors for the use of Batelco's technicians as well as documents informing and confirming the acceptance of the service delivery to the end-user);
  - b) Documents describing the provisioning processes of broadband access (if relevant, including documents originating from Batelco's vendors for the use of Batelco's technicians as well as documents informing and confirming the acceptance of the service delivery to the end-user);
  - c) Documents describing fault management processes on active copper lines (if relevant, including documents originating from Batelco's vendors for the use of Batelco's technicians);

**An Access Order Relating Local Loop Unbundling, Bitstream and Wholesale DSL issued pursuant to the Access Regulation**

- d) Documents describing the relevant Information Systems implemented inside Batelco (e.g. for Batelco staff and/or vendors to know the quality of the line or the status of the line, for Batelco staff and/or vendors to handle an order, etc.);
- e) Documents describing the current arrangements for Batelco's staff and contractors to access Batelco's sites.

**4. ANCILLARY SERVICES**

- 4.1 Batelco must provide the following LLU ancillary services to OLOs in its Reference Access Offer:
  - a) LLU Specific Information in accordance with paragraphs 3.7 to 3.10 of this Annex A;
  - b) LLU Backhaul and a corresponding Service Level Agreement;
  - c) LLU Service Node Collocation service;
  - d) LLU blocks and tie cables provision.
- 4.2 This list can be amended by TRA from time-to-time after consultation with stakeholders and publication of an amending Order.

**Ancillary Service # 1: LLU Specific Information**

- 4.3 In accordance with paragraphs 3.7 to 3.10 above Batelco must make available the following Specific Information to OLOs through its LLU SD, provided this is available at Batelco:
  - (a) The address of the Service Nodes;
  - (b) The number of active lines for LLU;
  - (c) The number of non-active for LLU;
  - (d) The average length of copper local loops (meters) measured at the exchange level;
  - (e) Power availability at each of Batelco's Service Nodes;
  - (f) Service Node space availability;
  - (g) Cable entry points (First manhole closest to the exchange) and duct capacity available;
  - (h) General information on cable characteristics (e.g. diameter, results from quality tests that have been conducted, technical interference, control and spectral management plan);
  - (i) Results of any xDSL tests.

**Ancillary Service # 2: LLU Backhaul and a corresponding Service Level Agreement**

- 4.4 Batelco must provide a LLU backhaul product with its LLU SD and a corresponding LLU Backhaul Service Level Agreement.
- 4.5 This will be reviewed and approved or ordered by TRA in accordance with article 5 of the Access Regulation.

**An Access Order Relating Local Loop Unbundling, Bitstream  
and Wholesale DSL issued pursuant to the Access Regulation**

**Ancillary Service # 3: LLU Service Node Collocation;**

- 4.6 Batelco must provide collocation space (including the Hand-over Distribution Frame) inside the Service Node to the OLOs to the extent that there is sufficient space. This can be either a dedicated or co-mingled space at the choice of the OLO.
- 4.7 Where adequate space is not available within the Batelco Service Node, Batelco is still required to provide collocation but this is required to be either sheltered or distant at the choice of the OLO.

**Initial Collocation process:**

- 4.8 TRA anticipates that the process for allocating collocation space at the start of the LLU project may be difficult and hence Batelco must implement the following if more than 3 operators apply for or provide written interest in LLU within 14 days from the commercial launch of LLU (“Initial Collocation Period”). For such collocation requests the following process must be followed:
- (a) Batelco informs TRA at the end of the Initial Collocation Period whether or not the Initial Collocation process is required.
  - (b) OLOs will specify their orders for the Server Node they intend to place an immediate order;
  - (c) Batelco will determine for each Service Node the best collocation option that will fulfil the demand within one month, based on orders received, and will send OLOs the corresponding collocation prices;
  - (d) OLOs will have two weeks to confirm their order based on the prices provided by Batelco. Confirmation will be accompanied by a non-refundable advance payment.

**Standard Collocation process:**

- 4.9 After the Initial Collocation Period has ended the following collocation rules must be followed:
- (a) **First Come First Served rule:** This rule ensures that OLOs that ask for collocation space earlier are served first. TRA believes that any other rule for allocating space may slow down the development of LLU. As is the case in duct and civil works, the first OLO shall bear all the associated costs and shall be reimbursed by other OLOs coming afterwards on a pro rata basis.
  - (b) **Use It or Lose It:** By this rule, if an OLO has been granted space but has not used this space after the specified reasonable period of time, the space will be released and re-allocated. This will prevent the inefficiencies created by hoarding space.
  - (c) **One single space allocated per OLO per Service Node.** Where space is scarce OLOs will be initially restricted to a single space. This restriction will be reviewed on an exchange-by-exchange basis to ensure proportionality. The definition and dimensions of a “space” will be determined through the field tests on the basis of the exchange equipment chosen by the OLOs.

**An Access Order Relating Local Loop Unbundling, Bitstream and Wholesale DSL issued pursuant to the Access Regulation**

- (d) Batelco should rely on effective demand for site preparation and as a general rule it should not be required of Batelco to provide space in advance for all or part of its Service Node sites.
  - (e) If several collocation options are available, the co-mingling option should always be proposed, and then, if no space is available for this option, the dedicated room option should be proposed, and then if no space is available for this option, the shelter option should be proposed, and then if no space is available for this option, the distant collocation option should be considered. In all cases the OLO will have the option to decide which collocation setup to choose.
- 4.10 Collocation minimum requirements will be:
- (a) the maintenance of space;
  - (b) access to power;
  - (c) OLO access to the allocated collocation space;
  - (d) Installation of an Optic Distribution Frame (“ODF”) on which one extremity of the backhaul to the OLO’s core network, in case the backhaul is provided by the incumbent;
  - (e) a Hand Over Distribution Frame (“HDF”) to which the tie cables are attached;
  - (f) fire suppression systems;
  - (g) air handling;

## **5. ACCESS NETWORK FREQUENCY PLAN**

- 5.1 Batelco must continue to provide the Access Network Frequency Plan (“ANFP”) that is released during the Field Test in accordance with paragraph 8.10 of this Annex. The Access Network Frequency Plan shall be made available to any OLO requesting LLU from the time of the commercial launch of the LLU SD.
- 5.2 The ANFP may be reviewed by TRA during the LLU SD review and in a working group hosted by TRA with OLOs and manufacturers/suppliers as required.

## **6. WORKING GROUP**

- 6.1 TRA will establish a Working Group on LLU Operations and Service Schedules consisting of TRA, Batelco and all participating OLOs in the field tests which will meet on a regular basis.
- 6.2 The goals of this Working Group will be to analyze and refine any existing processes and SLA/KPI measures to suggest appropriate amendments to the LLU RO and review and propose amendments to the ANFP as necessary.

## **7. TARIFFS**

- 7.1 In accordance with articles 57(e) and 58 of Telecommunications Law and articles 4.2(f), 5 and 6.1 of the Access Regulation Batelco must submit and TRA will review and approve or order LLU prices. TRA shall take into consideration the current available costing information from Batelco as well as international benchmarking of LLU prices in relevant markets.

**An Access Order Relating Local Loop Unbundling, Bitstream  
and Wholesale DSL issued pursuant to the Access Regulation**

**8. LLU FIELD TEST**

- 8.1 Batelco must host a field test (“LLU Field Test”) with OLOs commencing on **11 October 2009** and ending 6 weeks from that date. Without prejudice to the provisions that follow, TRA will issue binding directions to Batelco and OLOs on how the LLU Field Test will be conducted.
- 8.2 Batelco must make all appropriate preparations in order for the LLU Field Test, at the Manama Service Node (MAN) and Seef Service Node (SEF), to start no later than 11 October 2009 and which will last for 6 weeks.
- 8.3 LLU Field Test collocation will be comingling collocation at each service node.
- 8.4 The LLU Field Test will involve a minimum of 10 and a maximum of 50 end-users for each participating OLO.
- 8.5 LLU Field Test costs will be distributed between Batelco and OLO as follows:
  - (a) Costs incurred as part of preparing the sites that are effectively and efficiently incurred by Batelco shall be included in a cost category called “LLU implementation costs”. They will be recovered by Batelco as approved or ordered by TRA.
  - (b) Costs in relation to the provision and usage of Backhauls incurred by OLOs must be borne by OLOs.
  - (c) All other costs related to equipment should be borne by the party owning and responsible for that equipment.
- 8.6 At the end of the LLU Field Tests, appropriate provisions shall be made so that end-users, having participated in the test, can migrate back to their original line setup or stay with the Field Test setup should they so choose and the OLO agrees to continue to provide service.
- 8.7 On completion of the Field Test any participating OLO has the right to continue to provide LLU based services to end-users that have taken part in the Field Test., Batelco is required to continue to provide the LLU and Ancillary services to any OLO that continues to provide LLU based services at a quality no less than that provided during the course of the Field Test.
- 8.8 The charges and Terms and Conditions for the LLU and Ancillary Services will be contained in the LLU SD and Reference Offer Schedule 3 Price List once approved or ordered by TRA. Such charges will apply respectively to the date of the day after completion of the Field Test.
- 8.9 TRA will share the information gathered through the Field Tests with participating OLOs in a working group and publish it on TRA's website (as deemed appropriate).
- 8.10 Batelco must release an Access Network Frequency Plan to the participating OLOs in the LLU Field Test no later than 14 days prior to the start date of the Field Test to allow OLOs to decide on the configurations to be used during the Field Test.

**Qualifications required for OLOs wishing to enter Field Test**

- 8.11 TRA will invite all OLOs to take part in this Field Test subject to OLOs complying with the following criteria:

**An Access Order Relating Local Loop Unbundling, Bitstream  
and Wholesale DSL issued pursuant to the Access Regulation**

- (a) They are properly licensed operators in the Kingdom of Bahrain;
  - (b) They have expressed in writing to TRA and Batelco, their intention to participate in the field test confirming:
    - i. OLOs must identify which of their core network sites backhaul will have to be provided by Batelco;
    - ii. That they are able to install their exchange equipment by the proposed first day of the field test;
    - iii. That acknowledge that they must enter into written agreements with at least 10 End Users, to be connected to the OLO's equipment at least 14 days prior to the start date of the Field Test.
- 8.12 TRA will verify the names of OLOs which comply with the criteria set out above and will make public the list of the OLOs participating in the Field Test at least 7 days before the beginning of the field test.

## **Annex B**

### **Implementation Report of Local Loop Unbundling in the Kingdom of Bahrain**



هيئة تنظيم الاتصالات  
Telecommunications Regulatory Authority

## Implementation Report for Local Loop Unbundling (LLU) in the Kingdom of Bahrain

### Final report

14 September 2009

**Purpose:** To determine the method by which Local Loop Unbundling (LLU) should be implemented in the Kingdom of Bahrain.

## Table of contents

LIST OF ACRONYMS .....	16
1 EXECUTIVE SUMMARY .....	17
2 INTRODUCTION .....	20
3 DESCRIPTION OF LOCAL LOOP UNBUNDLING .....	22
4 Defining the scope of LLU that would be appropriate to Bahrain.....	34
5 Capacity building of the industry prior to LLU implementation.....	38
6 Setting LLU rates.....	42
7 Anticipating the main operational issues that could occur during the initial LLU implementation phase.....	44
8 Monitoring the development of LLU .....	51
9 Operational or Structural Separation of the Local Loop.....	53
10 Key milestones of the LLU implementation phase .....	54

## LIST OF ACRONYMS

ANFP	Access Network Frequency Plan
ARCEP	Autorité de Régulation des Communications Electroniques et de la Poste (French telecommunications regulator)
DSL	Digital Subscriber Line
DSLAM	Digital Subscriber Line Access Multiplexer
ERG	European Regulators Group
EU	European Union
EU27	The 27 countries of the European Union
FWA	Fixed Wireless Access
HDF	Handover Distribution Frame
KPI	Key Performance Indicator
LS	Line Sharing
LLU	Local Loop Unbundling
MDF	Main Distribution Frame
MSAN	Multi-Service Access Node
NRA	National Regulatory Authority
ODF	Optical Distribution Frame
OLO	Other Licensed Operators
Ofcom	Office of Communications (UK telecommunications regulator)
Oftel	Office of Telecommunications (UK) superseded by Ofcom
RO	Reference (Access) Offer
RUO	Reference Unbundling Offer
SLA	Service Level Agreement
SLU	Sub Loop Unbundling
TRA	Telecommunications Regulatory Authority of the Kingdom of Bahrain
UK	United Kingdom

# 1 EXECUTIVE SUMMARY

1. TRA has determined Batelco dominant in the wholesale physical network infrastructure access market and in the wholesale broadband access market as per its recent Dominance Determination in Wholesale Broadband Market <sup>1</sup>.
2. TRA, having assessed the appropriateness of the following Access Obligations, has issued an Access Order that requires Batelco to provide Local Loop Unbundling (for the wholesale physical network infrastructure access market) and Bitstream (for the wholesale broadband access market).
3. LLU is a process by which copper local loops are connected to the networks of Other Licensed Operators (“OLO”) and are used for their own services including broadband, double play services such as Internet and Voice, triple play services such as Internet, Voice and Television and other services.
4. In light of the comments received from the industry and international best practices, TRA has set the following approach for the implementation of LLU in the Kingdom of Bahrain. TRA believes that such an approach will enable an effective, smooth and appropriate implementation of LLU in the specific case of the Kingdom of Bahrain.
5. Batelco should introduce Full LLU (as described below). The scope of lines allowed to be unbundled will include both active and non-active lines, to the extent that there is capacity available at the main and at the distribution network level. Other forms of LLU are not required under the current Access Order and may be subject to TRA’s review in the future. Such forms include but may not be limited to Shared LLU and Sub Loop Unbundling.
6. In order for the market to be “LLU-ready”, Batelco will need to present General Information on the size and the location of MDFs which should be published as part of the Reference Offer and made available to OLOs on a simple request, subject to a confidentiality agreement, where reasonably required by Batelco. While the information should be free of charge, the costs incurred by Batelco should be included in a cost category called “LLU implementation costs” that will be recovered by Batelco as approved or ordered by TRA.
7. TRA requires Batelco to make ready its exchange(s) namely Manama (MAN) and Seef (SEF) in order to perform LLU field tests starting 11 October 2009, and going on for a period of at least 6 weeks.
8. TRA is of the view that such field tests will enhance LLU knowledge for all parties, speed up the commercial launch of LLU to the benefit of end-users, enable the anticipation of operational issues and ease discussions between all parties involved. LLU field tests should be based on the comingling option and involve a minimum of 10 and a maximum of 50 end-users for each participating OLO. Field test costs will be distributed between Batelco and OLO where the OLO will be liable to pay any charges related to Backhauls and Batelco will bear costs related to the preparation of the sites for collocation. The costs incurred by Batelco should be included in a cost category called “LLU implementation costs” that will be recovered by Batelco, as

---

<sup>1</sup> TRA, “Dominance Determination in Wholesale Markets”, 14 September 2009 (Ref: MCD/09/09/064)

approved or ordered by TRA. All other costs related to equipment should be incurred by the party owning and responsible for that equipment.

9. TRA will be organising workshops to discuss LLU commercial issues, type of services and technical/operational issues starting the first quarter of 2010 or as soon as deemed necessary by TRA.
10. TRA will review and approve or order LLU prices submitted by Batelco. For the first LLU prices, TRA shall take into consideration the current available costing information from Batelco as well as international benchmarking of LLU prices in relevant markets. TRA considers that “price on application” should be avoided wherever possible, thereby providing greater certainty and transparency to OLOs.
11. In order to anticipate operational issues that may occur for Batelco and OLOs, TRA defines appropriate actions to be taken on LLU operational processes; LLU-related general information; backhaul provisioning, space allocation; relationships between end-users, OLOs and Batelco; Access Network Frequency Plan (“ANFP”); bulk migration; forecasts; and Service Level Agreements (“SLAs”). Based upon this TRA orders the following:
  - a) LLU operational processes made available to OLOs must rely as much as possible on Batelco’s own processes and practices.
  - b) Batelco must make available, a detailed list of LLU-related information on OLOs’ requests <sup>2</sup>.
  - c) Batelco must provide a cost-based offer for LLU and all ancillary services.
  - d) Batelco should enable backhaul built by OLOs to access the Service Nodes.
  - e) Batelco must adopt specific rules for the provisioning of collocation, as well as a specific process for the very first collocation ordering which are further detailed in point 112 in this document.
  - f) End-users must be allowed to sign a document authorising an OLO to complete all the necessary actions. Termination of end users contract with Batelco must not be a condition to change from Batelco to an OLO.
  - g) Batelco must release its ANFP plan for the field tests. (The ANFP should be made available to OLOs no later than 14 days prior to the start of the field tests).
  - h) Batelco may require OLOs to provide some forecasts to Batelco regarding their LLU plans in order to help Batelco anticipate and plan associated activities. However, forecast requirements must not unduly constrain OLOs, such forecasts will only be provided for planning purposes and will not have any penalty implications on OLOs. Having said that, Batelco should provide

---

<sup>2</sup> This information is confidential and cannot be used by the OLO for any purpose other than the analysis and implementation of LLU. The information cannot be provided to any third party unless agreed to by Batelco or if required by law. Should the OLO wish to provide external consultants with the information for the purposes of advising it on LLU analysis and implementation it must seek Batelco’s written permission, which must not be unreasonably withheld. Batelco may insist that the consultant enter into a non-disclosure agreement with the OLO and Batelco.

all LLU information and Ancillary services as per the timelines identified in this Implementation Report.

- i) The following minimum parameters must be set for SLAs:
- i. For Full LLU line delivery, validation time and delivery time;
  - ii. For ancillary services, validation time and delivery time;
  - iii. For fault clearance, validation time and repair time.

For the purpose of this paragraph “validation time” refers to the time taken by Batelco between receiving the order or fault notification and the point of final assessment of the validity of that order or fault notification.

12. Once LLU is implemented, Batelco should periodically report Key Performance Indicators (“KPIs”) to TRA (as part of the regulatory requirements relating to the Quality of Service) and where appropriate to OLOs. TRA may publish an LLU scorecard that will include the number of unbundled lines, the number of unbundled MDFs and the LLU coverage.
13. TRA may create a Working Group on LLU Operations and Service Schedules, which will review the progress of LLU and suggest amendments to the LLU RO, and a Working Group on ANFP to discuss the evolution of and amendments to the ANFP.
14. Finally, TRA reserves the right to consider structural separation of Batelco should it be deemed necessary in the future.
15. TRA has taken action for implementing the outcome of this report in this Access Order to which this report is attached.

## 2 INTRODUCTION

16. This document studies the various approaches available for the implementation of Local Loop Unbundling (“LLU”) and establishes the reasons and approach adopted for the implementation of LLU in the Kingdom of Bahrain.
17. LLU is a process by which copper local loops are connected to Other Licensed Operator (“OLO”)’s networks and are used for their own broadband (e.g. double play services such as Internet and Voice, or triple play services such as Internet, Voice and Television) and other connectivity services. LLU can also be used to provide fixed telephony services only, although in practice it is used primarily to provide broadband and connectivity services.
18. On 28 February 2008, TRA published a report on the Strategic and Retail Market Review (“SRMR”), which detailed a set of regulatory measures designed to further promote competition in the Kingdom of Bahrain and support the implementation of the second National Telecommunications Plan. One of the measures envisaged in the SRMR was the unbundling of local loop based on the following rationale: “TRA considers that LLU can be an essential enabler of further competition at the retail level, especially for the provision of broadband and connectivity services to business users. LLU can be expected to put pressure on prices and to increase product differentiation for the benefits of users. LLU will be an additional wholesale product, not a replacement for any existing products (e.g. Bitstream)”<sup>3</sup>.
19. TRA issued a Draft Determination on Wholesale Broadband Markets (“the Draft Dominance Determination”)<sup>4</sup>, wherein TRA outlined reasons that supported a determination of Bahrain Telecommunications Company B.S.C. (“Batelco”) as a dominant operator in the “Wholesale Physical Network Infrastructure Access Market”. TRA has since considered all responses to its consultation on that draft and consequently, Batelco has been ordered to provide LLU as an Access Obligation under the Access Order relating to Unbundling Local Loop, Bitstream and Wholesale DSL<sup>5</sup> and to publish the relevant terms, conditions and tariffs in its Reference Offer (“RO”).
20. This report is structured as follows:
  - a) Section 2 describes the LLU product;
  - b) Section 3 defines the scope of LLU deemed appropriate to Bahrain;
  - c) Section 4 outlines the different capacity building actions necessary to facilitate the adoption and uptake of LLU by market players;
  - d) Section 5 discusses the principles used for setting the initial LLU prices;
  - e) Section 6 identifies the main operational issues that could occur with the implementation of LLU, drawing on LLU experience in other countries, and proposes options to mitigate these prior to the implementation of LLU;

---

<sup>3</sup> See: TRA, “Statement on the strategic and retail market review”, 3 June 2008 (Ref: MCD/0508/046), Page 5 & 6.

<sup>4</sup> TRA, Draft Dominance Determination in Wholesale Broadband Markets, March 2009

<sup>5</sup> TRA, Access Order relating Unbundling Local Loop, Bitstream and Wholesale DSL, 14 September 2009 (Reference MCD/09/09/065)

- f) Section 7 describes the actions TRA will undertake to monitor the development of LLU; and
- g) Section 8 discusses the relevance of operational or structural separation of the local loop in the Kingdom of Bahrain in the context of LLU.

21. In developing this approach, TRA has considered the opinions of the industry. TRA has also considered approaches followed by other regulators and has taken into account the specific characteristics of the local market, including the relative size of Bahrain's telecommunications sector. In doing so, TRA has sought to ensure that this approach is consistent with international best practices and does not impose a disproportionate burden on any of the parties involved.

### 3 DESCRIPTION OF LOCAL LOOP UNBUNDLING

#### 3.1 Definitions and rationale for LLU

- 22. The local loop is the “last mile” of an operator’s fixed telecommunication network. It forms part of the access network that connects the customer’s premises to the operator’s core network. In the European “Access Directive”<sup>6</sup>, the local loop is defined as “the physical circuit connecting the network termination point at the subscriber’s premises to the main distribution frame or equivalent facility in the fixed public telephone network.”
- 23. Pursuant to the Determination on Dominance in Wholesale Broadband Markets<sup>7</sup>, this report on the appropriate approach for the implementation of LLU in the Kingdom of Bahrain is concerned only with the copper local loop. The copper local loop is made of passive equipment: copper, boxes, chambers, frames (like the distribution point or the street cabinet), etc. It is deployed either underground in trenches or overhead on poles.

Figure 1 - Scope of the copper local loop and of the core network and associated terms

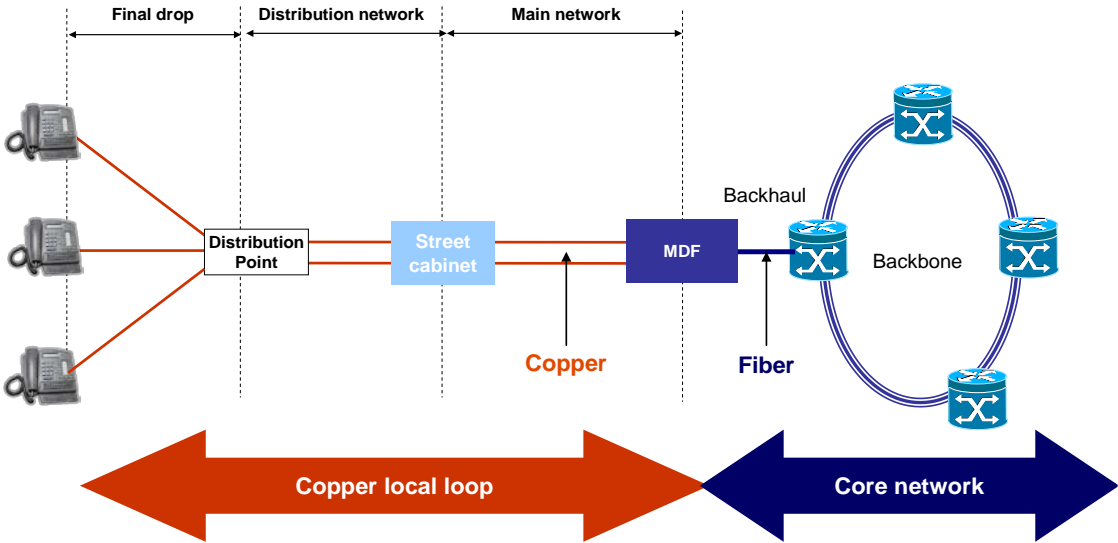

- 24. LLU is a wholesale product whereby the incumbent’s local loop is physically connected to an OLO’s exchange equipment (including but not limited to the Digital Subscriber Line Access Multiplexer/Multiservice Access Node, “DSLAM/MSAN”) so that the OLO gains access to customer premises and provides communication services such as broadband services using the Digital Subscriber Line (“DSL”) technology. The local loop remains the property of the incumbent, but in return for the rent paid the incumbent is expected to ensure maintenance of the local loop.

<sup>6</sup> Directive 2002/19/EC of the European Parliament and of the Council of 7 March 2002 on access to, and interconnection of, electronic communications networks and associated facilities (Access Directive), Page 5, Section (e).

<sup>7</sup> TRA, Dominance Determination in Wholesale Broadband Markets, 14 September 2009

25. Since the local loop connects most buildings in a given country, it is economically very difficult for it to be replicated by OLOs. As a consequence, LLU has been introduced in many countries to allow OLOs to compete with the incumbent especially for the provision of broadband services without having to deploy their own copper local loop. As discussed in Section 5 of the present report, the setting of LLU prices is a major issue in the implementation of LLU.
26. LLU is traditionally considered to be near the top of the investment ladder for broadband and connectivity services<sup>8</sup> while Bitstream access and Wholesale DSL (resale) products are closer to the bottom. Unlike the Wholesale DSL or the Bitstream access products that require limited investment and network deployment, LLU requires OLOs to deploy their own network up to each Service Node/Main Distribution Frame (“MDF”) that serves the customers they wish to address. Compared to the Wholesale DSL or the Bitstream products, LLU allows OLOs to differentiate their product from broadband and connectivity products sold by the incumbent. More specifically:
- a) retail products sold on the basis of the Wholesale DSL product have exactly the same features as the products of the incumbent;
  - b) retail products sold on the basis of the Bitstream product are managed by the incumbent’s exchange equipment, namely the DSLAM/MSAN, which means that they have very similar features to the ones of the incumbent;
  - c) with LLU, the retail products sold by OLOs use the OLO’s own exchange equipment (including but not limited to DSLAM/MSAN), which means that the products can be differentiated from the incumbent’s retail products. In fact, LLU has enabled OLOs in many European countries to innovate by proposing triple play services (i.e. voice, broadband Internet and television) – in some cases even before the incumbent.

---

<sup>8</sup> LLU also allows OLOs to offer fixed telephony services although overseas experience tends to show that OLOs use LLU primarily to provide broadband (e.g. double play services such as Internet and Voice, or triple play services such as Internet, Voice and Television) and connectivity services.

**Figure 2 - Relative level of network investment required by OLOs with LLU, Bitstream and Wholesale DSL**

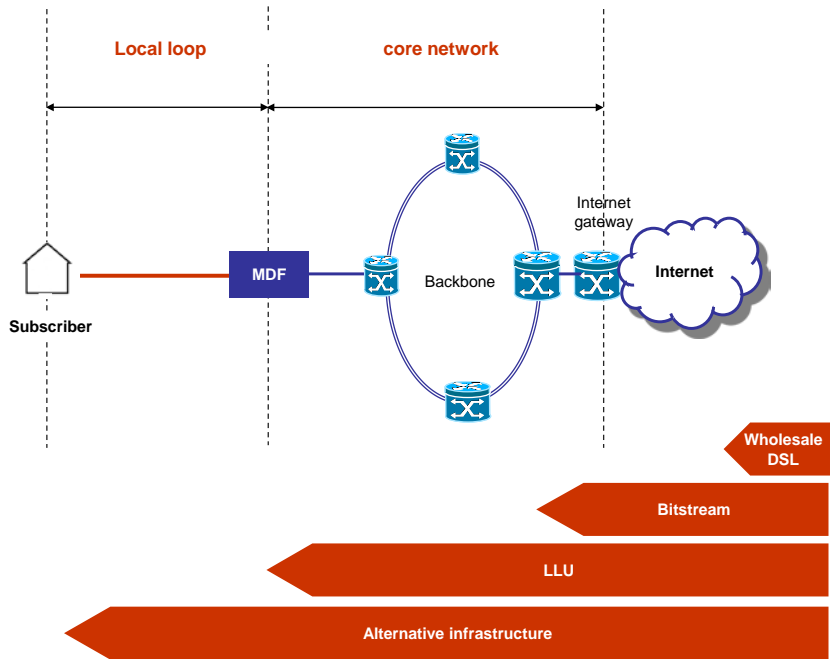

### 3.2 Description of the Full LLU product

27. Two types of LLU products are generally offered by incumbents and implemented through their Reference Offer: Full LLU and Line Sharing (“LS”).
28. With Full LLU, the incumbent provides OLOs access to the full spectrum of the copper pair. This means that end-users are not connected anymore to the incumbent’s core network and that only OLOs are offering services and connectivity: voice and broadband services are fully managed by the OLO. In addition to that, the end-user is not paying any charge related to the copper local loop to the incumbent (e.g. he/she is no longer required to pay for the retail monthly rental charge to the incumbent).
29. The provision of the Full LLU product by the incumbent to OLOs is performed through:
  - a) the disconnection of the end-user copper line from the incumbent’s network;
  - b) the installation of a tie cable and a jumper that will ensure connectivity between the end-user copper line and the OLO’s equipment installed close to the MDF.

Figure 3 - Provision of the Full LLU product at the MDF level

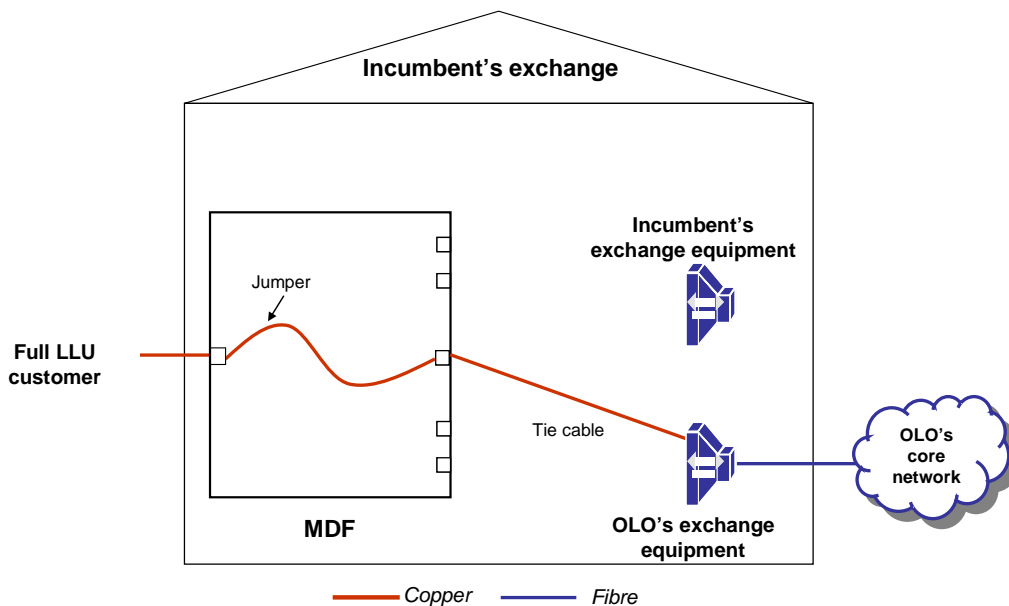

### 3.3 Description of the line sharing product

30. With Line Sharing (“LS”), also called “shared access”, the incumbent provides OLOs access to the non-voice band frequency spectrum of the copper pair. This means that end-users are connected to both the incumbent’s network for the provision of narrowband phone services (in general voice services) and to the OLO’s network for the provision of broadband services (broadband Internet access, voice over broadband, etc.). The end-user retains a commercial relationship with the incumbent for the provision of the narrowband services (the incumbent charges the PSTN monthly rental charge to the end-user and the end-user’s phone number remains attached to the incumbent’s voice service). However, for the provision of broadband services, the commercial and technical relationship with the end-user is managed only by the OLO.
31. The provision of the LS product by the incumbent to the OLO is performed through:
- the installation of a splitter at the MDF (either using MDF blocks that include splitters, using specific frames supporting splitters or using splitters installed on the OLO’s DSLAM);
  - the installation of a tie cable (including the corresponding Hand Over Distribution Frame) and jumpers that will ensure the connectivity between the end-user copper line, the splitter and the incumbent’s PSTN network on the one hand and the end-user copper line, the splitter and the OLO’s network on the other hand.

**Figure 4 - Provision of the LS product at the MDF level (for illustrative purposes with the configuration where the splitter is installed in a MDF block)**

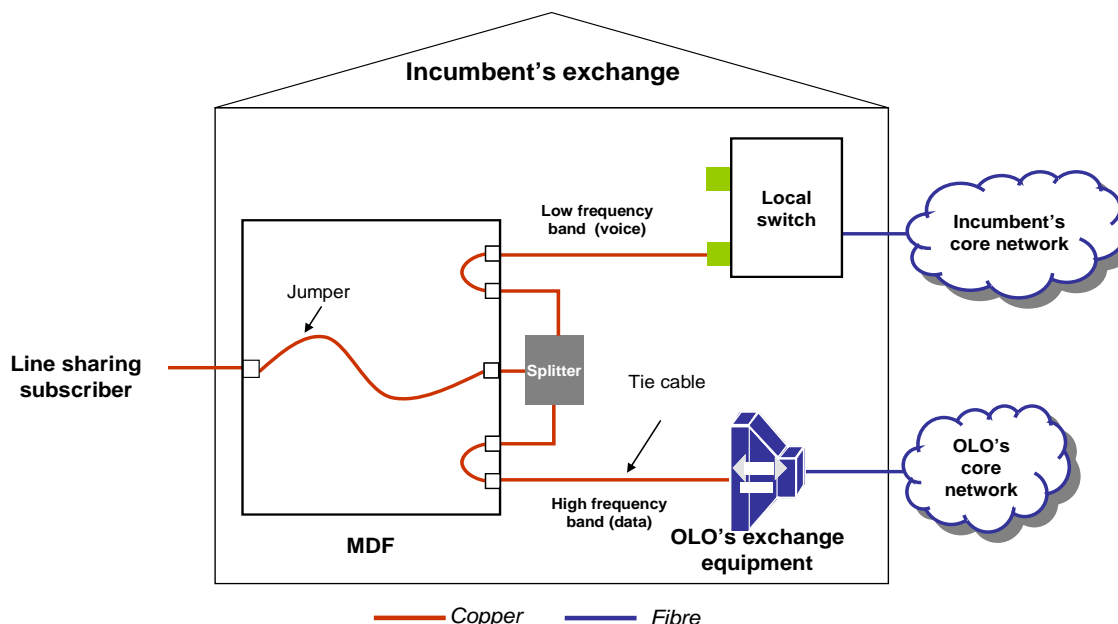

### 3.4 Description of Sub Loop Unbundling

32. Sub-Loop Unbundling (“SLU”) is a form of unbundling of the copper local loop by which OLOs do not rent the whole local loop but only the part of the local loop that extends between the customer premises and the street cabinet of the incumbent. The demarcation point between the incumbent’s network and the OLO’s network is the street cabinet and not the MDF as is the case for full or LS LLU.

Figure 5 - Scope of the sub loop

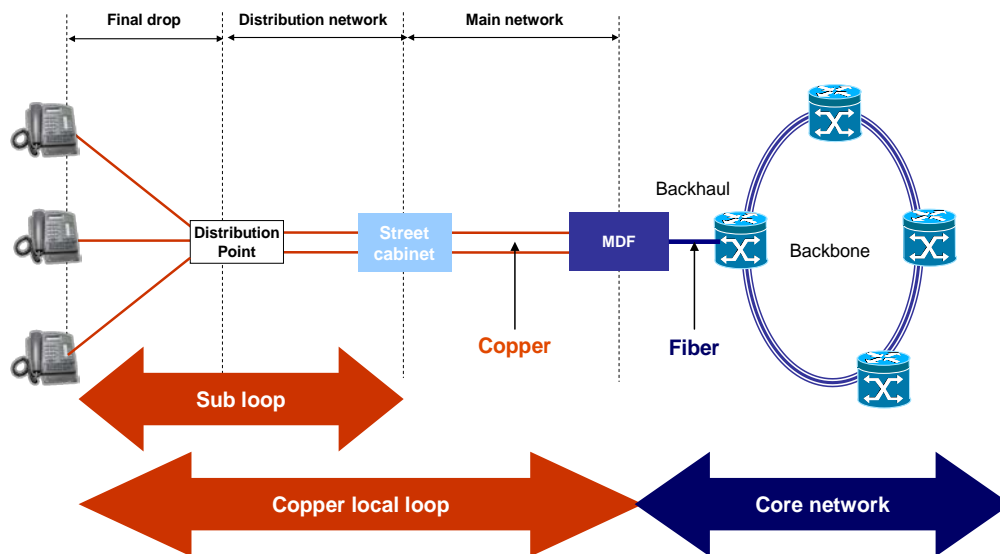

33. The objective of SLU is to shorten the distance between the customer premises and the OLO’s equipment. The performances of DSL technologies are sensitive to distances: the shorter the distance between end-users and OLO equipment is, the higher the performances of DSL (e.g. download speed).
34. SLU requires OLOs to install their equipment very close to the street cabinet of the incumbent. SLU requires OLOs to install equipment in more locations and to deploy more extensive backhaul solutions than LLU, and therefore, compared to LLU, SLU stands higher in the investment ladder.

**Figure 6 - Relative level of network investment required by OLOs with SLU, LLU, Bitstream and Wholesale DSL**

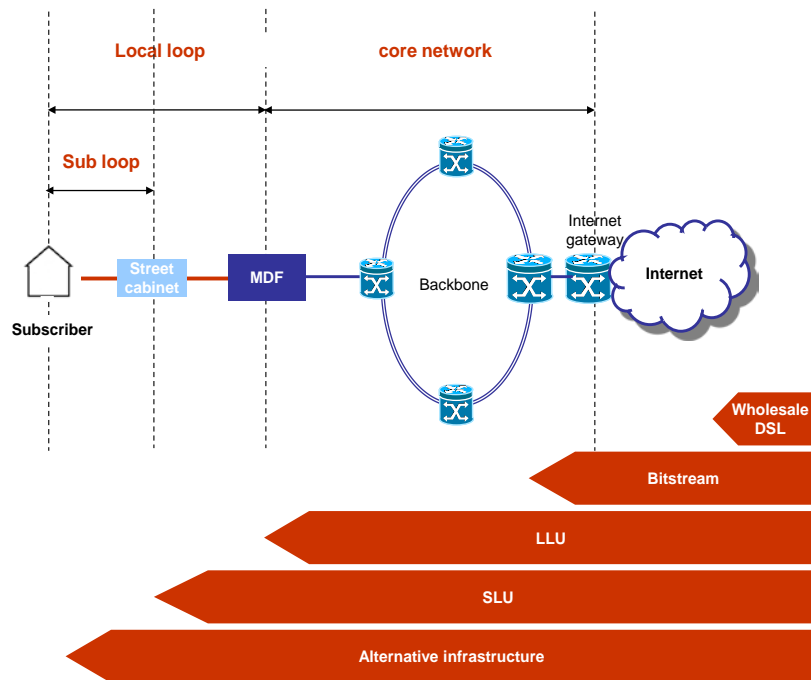

35. As with LLU, two SLU products could be envisaged: a Line Sharing SLU product and a full SLU product.

### 3.5 Description of key ancillary services to LLU

36. For the incumbent, LLU is the provision of local loop access to OLOs. However, to ensure end-to-end connectivity and the effectiveness of LLU between end-users and OLOs, the incumbent has to provide a set of services on top of the basic LLU service. These key additional services are called ancillary services which can be categorised as:
- The provision of information about its local loops;
  - The installation of tie cables between the MDF and the OLO's equipment;
  - In the case of LS, the installation of a splitter;
  - The provision of collocation space (including the Hand over Distribution Frame) inside the MDF site by the incumbent to the OLOs;
  - The provision of a backhaul solution between the OLO's equipment installed inside the MDF site and the OLO's Point of Presence located outside the MDF site.

These ancillary services are described in more detail below.

**Figure 7 - List of basic and ancillary services to be provided by the incumbent to OLOs**

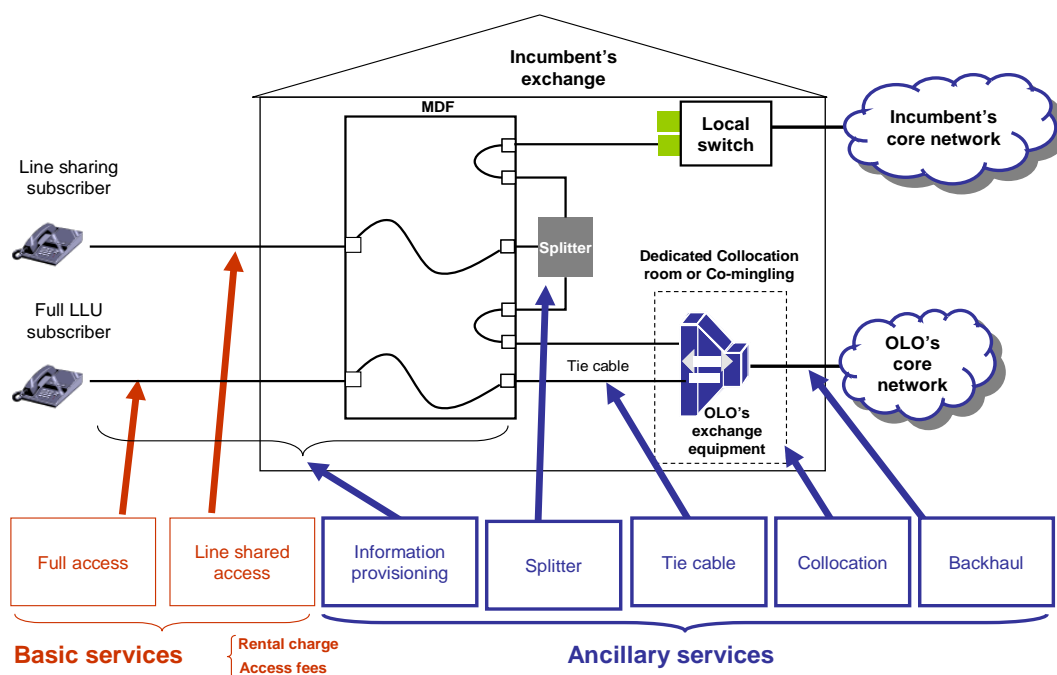

37. In order for the OLOs to decide which MDFs they wish to unbundle, to plan their business and network, and to acquire a deeper knowledge of the local loop, OLOs need to get sufficiently detailed information about the incumbent's local loop. Typically, in countries where LLU has been implemented, the incumbent provides at least information about the location of MDFs, the coverage of MDFs, the capacity of MDFs, the quality and features of copper lines, etc. Some of this information is free of charge and publicly available (like the number of MDFs and their capacity) and some is confidential (See sections 5.2 and 7.3 for further details).
38. To ensure connectivity between the OLO's equipment and the MDF, the incumbent has to install a tie cable between the MDF and the OLO's equipment. Since access to the MDF is restricted to the incumbent, the tie cable can only be installed by the incumbent. The provision of tie cables can either be said to be "external" if the OLO's equipment is not located inside the MDF site or "internal" if the OLO's equipment is located inside the MDF site.
39. In the case of LS, a splitter is required. Depending on the configuration chosen, the splitter can either be provided by the incumbent or by OLOs (since a lot of new generation equipment and DSLAMs are equipped with internal splitters).
40. As explained above, the DSL technology used by OLOs in the context of LLU is sensitive to the distance between the equipment and end-users. As a consequence, OLOs need to install their equipment as close as possible to the end-users, namely, in the case of LLU, as close as possible to the MDF. This is why the incumbent is usually requested to provide collocation space to OLOs in its MDF sites wherever space is available. There are several forms of collocation that can be envisaged depending on the specific setup of the MDF site:

- a) The provision of space in the same room as the incumbent's equipment: this is called **co-mingling**;

**Figure 8 - Provision of a co-mingling to OLOs**

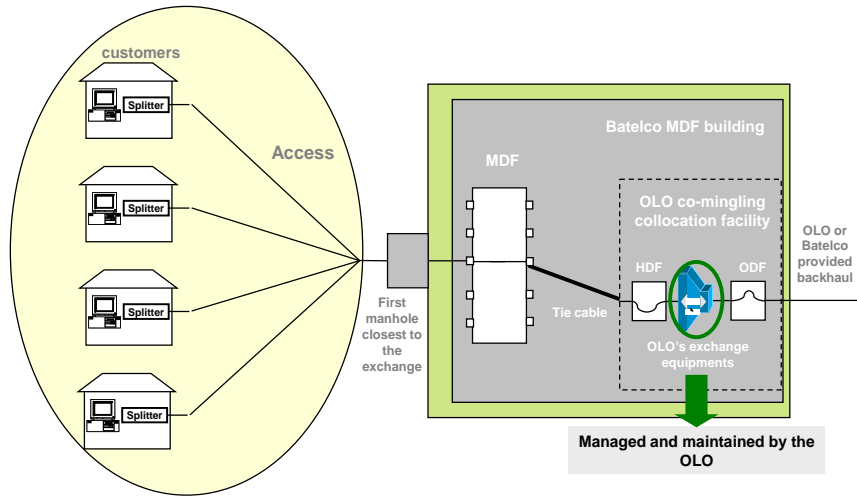

- b) The provision of space in a room dedicated to LLU: this is called **dedicated collocation**; and

**Figure 9 - Provision of a dedicated room to OLOs**

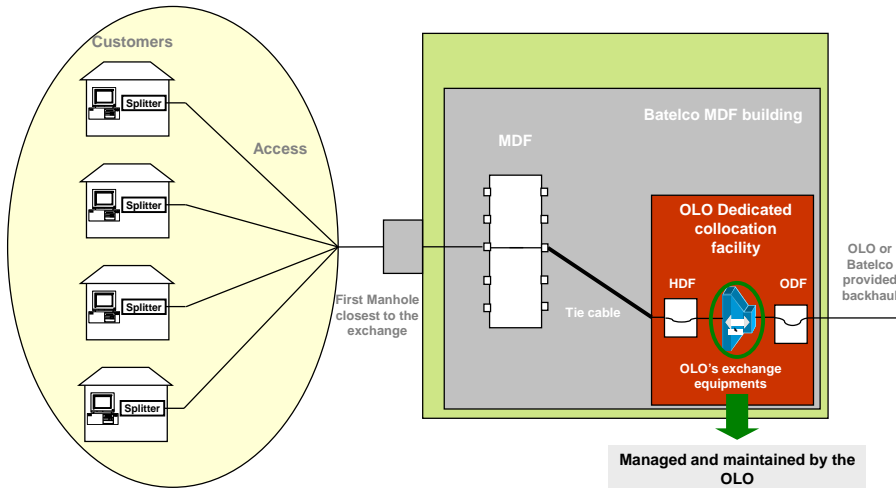

- c) The provision of space outside the MDF building but inside the incumbent's property in a shelter: this is called **shelter collocation**.

**Figure 10 - Provision of a shelter by the incumbent to OLOs**

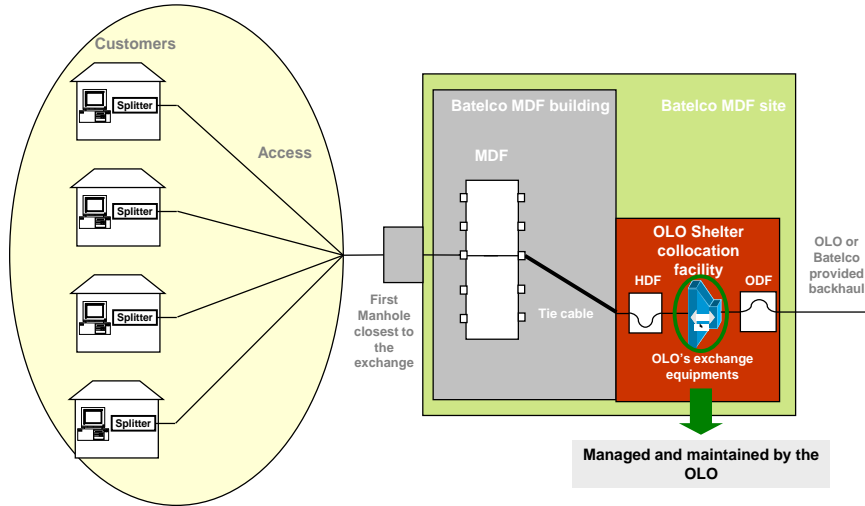

41. Two other forms of collocation are sometimes envisaged but very rarely used in countries where LLU has been implemented:

- a) **Distant collocation** where the OLO deploys its equipment in its own premises located very close to the incumbent's MDF. An "external" tie cable connects the OLO's equipment to the MDF and passes through the first manhole closest to the exchange of the MDF site.

**Figure 11 - Distant collocation**

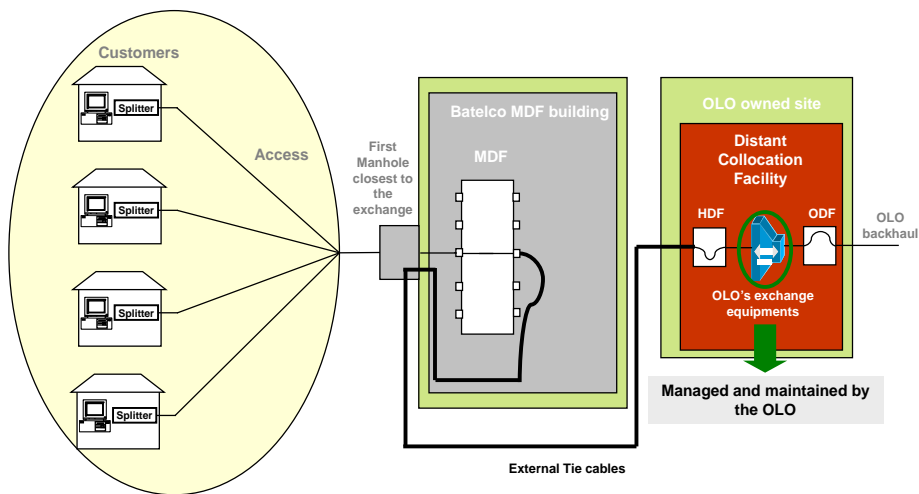

- b) **Virtual collocation** where the equipment of the OLOs is installed inside the MDF site but maintained by the incumbent.

**Figure 12 - Virtual collocation**

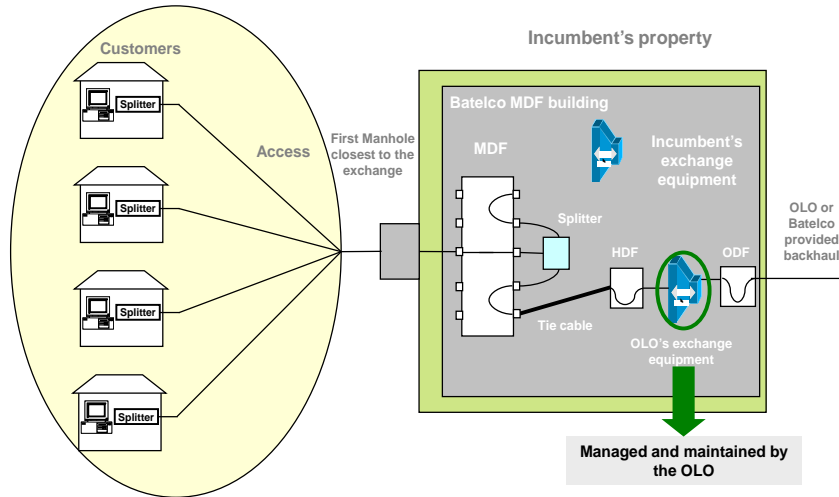

42. The incumbent's provisioning of collocation space is also accompanied by the provision of: maintenance of space; access to power; cooling; OLO access to the allocated collocation space; an Optic Distribution Frame ("ODF") on which one extremity of the backhaul to the OLO's core network, in case the backhaul is provided by the incumbent, is installed; and a Hand Over Distribution Frame ("HDF") to which the tie cables are attached.
43. The last type of service to be provided by the incumbent is a backhaul service. The backhaul service enables OLOs to connect their equipment, installed inside the MDF site of the incumbent, to an OLO's point of presence. Since one extremity of the backhaul is located inside the MDF site, the incumbent needs to provide a backhaul service option, e.g., through a leased line type of offer. However, backhaul can also be deployed by the OLO itself by pulling fibre from the MDF site to its point of presence with the assistance of the incumbent for the part of the backhaul that has to be deployed inside the incumbent's property. Typically, the deployment of backhaul by OLOs is not economically viable in all MDF sites.

### 3.6 Description of actions to be completed by OLOs

44. While it is required that the incumbent provides the aforementioned ancillary services to OLOs to make LLU effective, OLOs have to carry out a certain number of tasks in order to offer services based on LLU, including:
- Identify the MDFs where they want to deploy their equipment;
  - Ask the incumbent for space in these MDFs for collocation (or find a site close to the MDF);
  - Buy, install and maintain equipment;
  - Connect the equipment through a backhaul service to their core network;

- e) Install sufficient servers and capabilities in the core network for the provision of DSL services to end-users;
- f) Buy Internet connectivity when appropriate;
- g) Plan for and request the incumbent to deploy tie cables between the MDF and the HDF;
- h) Market services to customers;
- i) Receive orders from customers;
- j) Request the incumbent to provision the local loop access for its customers;
- k) Provide and install appropriate customer premise equipment (modem, splitters, etc.) at the customer premises;
- l) Maintain the end-to-end connectivity.

## **4 Defining the scope of LLU that would be appropriate to Bahrain**

### **4.1 Should both Full LLU and LS be implemented or only one of these products?**

45. Full LLU and LS are similar wholesale products. However, LS appears to be more complex to implement than Full LLU. Since it requires the use of splitters, LS requires the end-user to maintain a contractual relationship with Batelco and to establish a new contractual relationship with the serving OLO.
46. In almost all European countries, both Full LLU and LS products are offered by the incumbent. However, having considered the factors below, TRA is of the view that only Full LLU should be implemented.

#### *Simplicity and benefits to end-users*

47. While some end-users may prefer keeping a commercial link with Batelco for the provision of voice services, TRA notices that, with the development of mobile telephony and FWA offers, a number of end-users have no commercial relationship with Batelco as a fixed operator. Also, if fixed number portability is implemented, Full LLU will allow end-users to use OLOs' voice service and keep their phone number. This will not be possible with LS (the phone number will remain dedicated to Batelco's voice service). TRA is of the view that keeping the same phone number is valuable for end-users, especially for business users.

#### *OLOs' point of view*

48. Though some OLOs may wish to only provide internet access, interviews held by TRA in November 2008 with respect to LLU indicated that OLOs wish to provide multi-play services including voice services and to avoid the existence of a mandatory commercial relationship between their end users and Batelco.

#### *Operational implementation*

49. TRA is of the view that having two LLU wholesale products will complicate the implementation for both Batelco and OLOs. While the LS product is similar to the Full LLU product, TRA anticipates that the involvement of Batelco in the customer relationship may create difficulties. Further, LS requires separating narrowband and broadband signals through the installation of splitters and other jumpers at the MDF and this may increase the risk of MDF congestion.
50. TRA finally notes that in the context of Batelco's NGN deployment, the provision of the LS product may become particularly difficult since the voice services are no longer supported by the incumbent's PSTN network but by the incumbent's NGN network.
51. TRA therefore considers that it must focus the effort of the industry on the wholesale product which has the greatest potential and interest, i.e., full LLU.

#### *International experience*

52. In reviewing international experience with LLU implementation, TRA also notices that, while LS has been a stepping stone towards Full LLU in some European countries

like France, many countries like Germany, Italy, Denmark, Austria, Cyprus, Luxembourg, Portugal, and Finland, have preferred Full LLU compared to LS. TRA also notes that in July 2008, in EU27, there was twice the number of Full LLU lines compared to LS lines<sup>9</sup>. Furthermore, in countries in which LS uptake had been initially strong, these lines were being substituted by Full LLU. Consequently, international experience does not indicate that LS is a prerequisite for LLU to be successful.

### *Pricing*

53. The pricing of LS can be problematic when retail tariffs for fixed telephony services are not fully aligned with underlying cost. In this configuration, the LS rate may not be significantly different from the Full LLU rate, and this would greatly reduce, if not eliminate, the attractiveness of LS.

### *Conclusion*

54. For the reasons set out above, TRA is of the view that, in order to ensure the effective and smooth implementation of LLU, Full LLU should be implemented for the time being.

## **4.2 Is SLU suitable for Bahrain at this point in time?**

55. Like LS, the suitability of SLU for Bahrain is questionable. TRA notices first that while SLU is available in European countries, there have been no significant commercial deployments of SLU in Europe to date, despite the launch of VDSL plans by some incumbents.
56. Furthermore, OLO equipment has to be located inside street cabinets where air conditioning has to be made available and which makes the deployment much more difficult, especially in Bahrain due to local weather conditions. Finally, the provision of backhaul to the street cabinets may prove to be a disproportionate burden to be imposed.
57. Taking into consideration the advantages of SLU compared to LLU in terms of DSL performance and the questionable viability of SLU due to the limited economies of scale, TRA is of the view that the additional requirement to implement SLU would unnecessarily complicate the implementation of LLU at this point in time and offer very few benefits.
58. As a consequence, TRA will not implement SLU for the time being. However, this decision may be reviewed once LLU has been commercially implemented.

---

<sup>9</sup> Communications Committee, Working Document, Subject: Broadband access in the EU: situation at 1 July 2008

### 4.3 Should LLU be allowed only for active lines?

59. The provision of communications services by OLOs on the basis of LLU requires the existence of end-to-end physical connectivity from the customer premises to the equipment of the OLOs. This makes current active lines, i.e., lines where there is an existing end to end metallic pair in the copper access network in use to provide services to the corresponding end-user, obvious candidates for LLU.
60. However, in many countries such as France, Ireland, the United Kingdom, Malta and Cyprus, not only active lines are allowed to be unbundled but also non-active lines, i.e. copper lines that do not support any service for any end-user, for which there is capacity at both the main network level and the distribution level<sup>10</sup>. If, for a given customer premises, there is a copper pair available between the closest distribution point and the corresponding street cabinet and there is a copper pair available between this street cabinet and the corresponding MDF, the only work in terms of infrastructure to be done by Batelco to ensure end-to-end connectivity between the customer premises and the MDF is:
- The deployment of a copper final drop between the customer premises and the distribution point; and
  - The installation of a jumper at the street cabinet level.

**Figure 13 - Part of the local loop where capacity is required to ensure end-to-end connectivity**

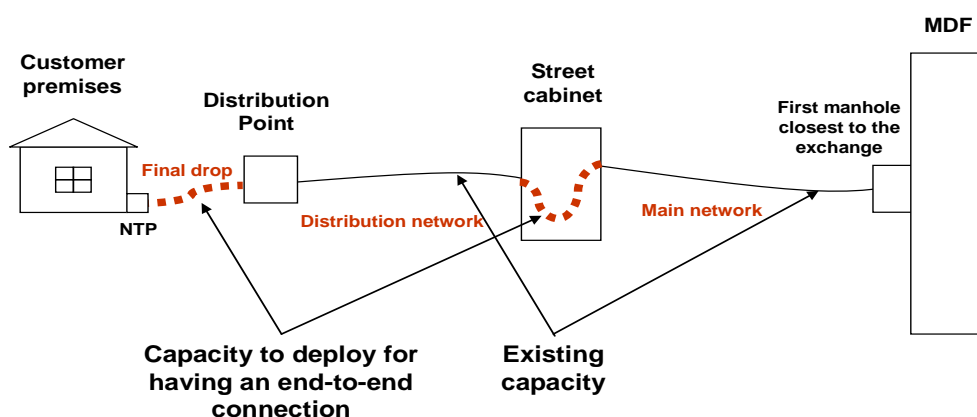

61. TRA is of the view that, if capacity exists at the main network level and at the distribution network level, non-active lines should be allowed to be unbundled for the following reasons:
- The work required to ensure end-to-end connectivity is relatively minor;
  - It is needed to allow the provision of leased lines services by OLOs with HDSL and SDSL services that can require two pairs;
  - In countries where the fixed penetration rate is not saturated, it increases the size of the addressable market bigger;

<sup>10</sup> The main network is the part of the local loop that stands between the street cabinet and the MDF. The distribution network is the part of the local loop that stands between the distribution point and the street cabinet.

f) The application of the non-discrimination principle requires allowing such lines to be unbundled since Batelco can use these lines for its retail activities.

62. Therefore, should a customer and OLO wish to be connected on a non-active line, then Batelco must allow that line to be unbundled, including if there is no final drop, by installing the final drop, which will be charged by Batelco to the OLO on a time and materials basis.
63. Batelco's refusal to unbundle non-active lines could only be based on objective technical reasons which should be justified in writing to both OLOs and TRA.
64. The scope of lines that can be unbundled shall therefore be active and non-active lines to the extent that there is at both the main network level and the distribution level.

## 5 Capacity building of the industry prior to LLU implementation

### 5.1 Introduction

- 65. Capacity building activities are an essential ingredient to ensure the successful implementation of LLU.
- 66. TRA interviewed different stakeholders in November 2008 to assess their views and needs with respect to LLU. While OLOs expressed a real and sometimes precise interest in LLU, TRA identified a need to develop further the knowledge of the industry on LLU prior to its implementation. In order for the market to be “LLU-ready” and to facilitate a smooth and effective introduction of LLU, TRA requires that Batelco undertake a number of specific actions as described below.

### 5.2 Provision of LLU-related general information prior to the availability of Batelco’s LLU offer on request and subject to a confidentiality agreement signed by the OLO.

- 67. Having reviewed Reference Unbundling Offers in other jurisdictions which include information on the copper access network, TRA is of the view that some general information on Batelco’s copper access network should be made available free of charge to OLOs by Batelco as soon as possible after the issuance of the Order<sup>11</sup>, on simple request and subject to a confidentiality agreement signed by the OLOs, if reasonably required by Batelco. For the avoidance of doubt, Batelco will be allowed to recover the efficiently incurred costs of preparing and providing the information
- 68. Based on information available on Batelco’s copper access network, TRA requires that LLU-related general information should be made available in advance of the Batelco LLU RO. This should include:

- a) **The list of MDFs with their category of size in Bahrain, as defined below:**

<b>MDF Size</b>	<b>MDF Name and Site</b>
More than 10,000 working lines	...
Between 7,500 and 10,000 working lines	...
Between 5,000 and 7,500 working lines	...
Between 2,500 and 5,000 working lines	...
Less than 2.500 working lines	...

- b) **The address and exchange boundaries of these MDFs on a map (except the ones for which valid national security reasons prevent their location or information being made public)..**

The information on the size of MDFs is necessary because the attractiveness of LLU is sensitive to economies of scale/densities. The information on the location is necessary because LLU requires OLOs to deploy a backhaul that will connect targeted MDFs and to “map” the targeted customers and corresponding MDF.

<sup>11</sup> TRA, Access Order relating Unbundling Local Loop, Bitstream and Wholesale DSL, 14 September 2009

69. This LLU-related general information shall form a part of the Reference Offer and shall be made available to OLOs on simple request, subject to a confidentiality agreement, where reasonably required by Batelco<sup>12</sup>.

### 5.3 LLU field tests

70. Following its review of international practices related to LLU implementation, TRA notices that in order to facilitate the smooth implementation of LLU some NRAs undertook field test experimentations. For example, in France, ARCEP organized field test experimentations in 2000 that involved both the incumbent and OLOs, during which OLOs had the opportunity to install their own DSL equipment in 12 of France Telecom's MDFs and to test the DSL technology and end-to-end connectivity with end-users. The lessons learned were discussed within a working group hosted by ARCEP and were used in the drafting process of the Reference Unbundling Offer.
71. TRA is of the view that substantial benefits from LLU field test experimentations can be expected for Batelco, for OLOs as well as for TRA itself since they should enhance LLU knowledge for all parties, speed up the commercial launch of LLU to the benefit of end-users, enable the anticipation of operational issues and ease discussions between all parties involved.
72. More specifically, field test experimentations would enable Batelco to build a dedicated LLU task force, to elaborate and refine the relevant provisions of the Reference Offer and the associated operational processes, to learn how to work with OLOs and to offer them LLU basic and ancillary services and to organize itself for an efficient provision of these LLU services.
73. OLOs could take advantage of these trials to test their equipment, to get know-how about the incumbent's local loop and associated features, to learn how to work with the LLU task force of the incumbent, to adapt or refine their plans related to LLU, to test with real end-users their future commercial offers, to learn more about the processes associated with LLU (for the creation of lines, for the maintenance of lines, etc.) and to identify any potential issues with respect to LLU implementation.
74. Finally, these field test experimentations would allow TRA to get a better understanding of constraints with LLU implementation of both parties and if possible to contribute to solving a large number of issues before commercial launch as well as anticipate eventual blocking points.
75. As a consequence, TRA is of the view that field tests should take place prior to the commercial launch of LLU. LLU field tests should start no later than 11 October 2009. TRA is of the view that LLU field tests should last for a minimum of 6 weeks. At the end of the field tests, appropriate provisions shall be made so that end-users, having participated in the test, can migrate back to their original line setup, or remain with the current setup and OLO should they end-users and OLOS choose so.
76. In preparation for these field tests, OLOs will have to contact manufacturers and vendors to select the appropriate equipment, to gather technical information, to be

---

<sup>12</sup> This information is confidential and cannot be used by the OLO for any purpose other than the analysis and implementation of LLU. The information cannot be provided to any third party unless agreed to by Batelco or if required by law. Should the OLO wish to provide external consultants with the information for the purposes of advising it on LLU analysis and implementation it must seek Batelco's written permission, which must not be unreasonably withheld. Batelco may insist that the consultant enter into a non-disclosure agreement with the OLO and Batelco.

trained to understand the functioning of such selected equipment, to envisage suitable backhaul solutions (fibre based) for these tests to be deployed with Batelco, and to select some end-users to complete these tests.

77. In order to have a productive field test, there must be at least 10 and at most 50 end-users involved in each participating OLO's test.
78. Field tests costs should be distributed between the OLOs and Batelco as follows:
  - a) Costs incurred as part of preparing the sites that are effectively and efficiently incurred by Batelco shall be included in a cost category called "LLU implementation costs" that will be recovered by Batelco as approved or ordered by TRA
  - b) Costs in relation to the provision and usage of Backhauls incurred by OLOs must be borne by OLOs.
  - c) All other costs related to equipment should be borne by the party owning and responsible for that equipment.

#### *Site selection*

79. Given the number of service nodes in Bahrain, TRA requires these field tests to take place in two of Batelco's Service Node sites. Based upon the information obtained from OLOs and Batelco during the November 2008 interviews, and taking into account space and appropriate backhaul availability, TRA has determined that the sites for the Field Tests are Manama Centre and Seef referred to by Batelco as MAN and SEF respectively. Batelco shall prepare the two selected sites and the corresponding backhaul to enable LLU field tests to occur.
80. Since TRA foresees collocation as one of the ancillary services that can generate a large number of operational issues, TRA is of the view that the collocation option to be considered during these trials to be the comingling option in the selected sites.
81. TRA will share the information gathered through the field tests with participating OLOs in a working group and publish it on TRA's website (as deemed appropriate).
82. TRA envisages that all interested OLOs should be able to take part in this field test subject to the following criteria:
  - a) They are properly licensed operators in the Kingdom of Bahrain;
  - b) They have expressed in writing to TRA, their intention to participate in the field test. TRA requests interested OLOs to mention to which of their core network sites backhaul would have to be provided by Batelco;
  - c) They are able to install their exchange equipment by the proposed first week of the field test;
  - d) They have entered a written agreement with the minimum number of end-users required, to be connected to the OLO's equipment in no less than 14 days prior to the proposed first date of the field test.
83. TRA will verify, at least 7 days before the beginning of the field test, the names of OLOs which comply with the four criteria set out above and will make public the list of the OLOs participating in the field test.

## 5.4 Capacity building workshops

84. TRA acknowledges that the LLU offer, included as a part of the Reference Offer, can incorporate very detailed product, technical and operational points. In order to explain and review in detail the main components of the LLU offer (relevant parts of the Reference Offer (“RO”)) with all operators, TRA envisages holding capacity building workshops before the commercial launch of LLU. These workshops will take into account, when appropriate, the findings of the LLU field tests.
85. TRA will host the following workshops to be held one (1) week prior to the Launch of LLU <sup>13</sup> with the following agenda:
  - a) **Day 1:** Commercial issues and the type of services (basic and ancillary LLU services);
  - b) **Days 2 & 3:** Technical/operational issues including processes, interference management plan, operational manuals, service details and procedures, etc.

---

<sup>13</sup> The exact workshop dates will be dependent on the progress of the LLU project and TRA will update the industry regarding the occurrence of such workshops.

## 6 Setting LLU rates

### 6.1 Introduction

86. International experience demonstrates that the level of LLU prices has a major impact on the development of LLU. ). This section presents how TRA intends to assess, and if necessary adjust, the rates submitted by Batelco for the first RO on LLU to ensure that they are fair and reasonable.

### 6.2 Pricing basic LLU services

87. The Telecommunications Law requires licensed operators in a dominant position to offer access on fair and reasonable terms. In order to assess whether the LLU rates proposed by Batelco in its LLU RO comply with the Telecommunications Law TRA will consider several sources of evidence. The objective of this is to derive a plausible range and, within that range, to select a point that best achieves the duties of TRA.
88. TRA considers that a combination of two main approaches should be used to establish a plausible range from which the initial prices for LLU services will be set.
89. The first approach consists of analysing Batelco's cost information currently available. It may be necessary to adjust this information to ensure that only those costs relevant to the LLU products are included.
90. The second approach is benchmarking. TRA is mindful that benchmarking comes in many flavours. "Simple" benchmarking can be performed, whereby rates in various jurisdictions are benchmarked. Simple benchmarking can usefully be complemented by "intelligent" benchmarking which involves selecting comparable countries to Bahrain in terms of size or other relevant cost drivers and for which LLU prices are available.
91. TRA intends to use a combination of both simple as well as more complex benchmarking techniques. Depending on the availability and accuracy of information gathered in other jurisdictions, TRA will adopt either one or both of the following methods of "intelligent benchmarking":
- a) **Peer group:** The first method consists of identifying a peer group of countries that are similar to Bahrain and to use the LLU rates adjusted to take into account the differences between Bahrain and the peer group with respect to key local loop cost drivers. TRA considers at this stage that the main local loop cost drivers are population density, fixed penetration and the cost of civil works.
  - b) **Econometric analysis:** The second method consists of the econometric estimation of the relationship between cost drivers and LLU rates in other jurisdictions. The estimated relationship is then used to predict the LLU rates in the target country.<sup>14</sup>

---

<sup>14</sup> See Commerce Commission, 2007, Standard Terms Determination for the designated service Telecom's unbundled copper local loop network, Decision 609, for an account of how LLU rates were set in New Zealand based on a sophisticated benchmarking approach, including via regression analysis.

### 6.3 Pricing LLU ancillary services

92. Following its review of international experience, TRA understands that the way ancillary services are priced can potentially constitute a barrier to entry for OLOs.
93. First, there is a tendency for incumbents to use “price on application” instead of published prices, which does not enable OLOs to estimate the level of charge they will have to support. TRA believes that “price on application” should be avoided wherever possible, thereby providing greater certainty and transparency to OLOs.
94. Second, because incumbents tend to propose high upfront fees, TRA believes that ancillary service upfront fees should, as far as possible, be annualized and transformed into recurring fees as described in ARCEP’s decision n° 02-278<sup>15</sup> and Oftel’s consultation document “Local loop unbundling: provision of collocation in the form of co-mingling”<sup>16</sup>. This could be done through the use of a depreciation formula, the cost of capital and an appropriate depreciation period. Annualized upfront fees help OLOs realize their business plans as barriers to entry created by high upfront costs are lowered..

---

<sup>15</sup> [http://www.arcep.fr/uploads/tx\\_gsavis/02-278.pdf](http://www.arcep.fr/uploads/tx_gsavis/02-278.pdf)

<sup>16</sup> Local loop unbundling: provision of collocation in the form of co-mingling, Statement and Direction issued by the Director General of Telecommunications, 10 October 2001

## **7 Anticipating the main operational issues that could occur during the initial LLU implementation phase**

### **7.1 Introduction**

95. Operational issues have significantly slowed down the roll out of LLU in some countries where LLU has been implemented. The objective of this section of the report is to anticipate operational issues that may occur and identify remedial actions.

### **7.2 The principle of non-discrimination**

96. One of the main principles that should guide the definition of operational processes and the drafting of the LLU offer is the principle of non-discrimination. The application of this principle shall ensure that Batelco gives OLOs access to its local loop (and all associated services) in a similar way to its own retail activities.
97. TRA is of the view that the definition of operational processes and the drafting of the LLU offer should rely as much as possible on Batelco's own processes and practices.
98. TRA is aware that, on Batelco's website, the provision of lines is supposed to be performed within 1 to 5 working days: "You can expect your Speednet service to be activated within 1-5 working days, subject to the availability of the ADSL service in your area of residence and telephone line condition. In some cases, activation of the service may take up to one (1) month or more, depending on the service start-up requirements."<sup>17</sup> The application of the non-discrimination principle requires Batelco to provide LLU lines also within the same time frame.
99. TRA will require from Batelco no later than 30 days from the date of the Access Order a list and description of internal processes pertaining to the provisioning of lines, together with any associated commitments towards its own end-users such as the above, including:
- a) Documents describing the processes by which the provision of a line is performed (if relevant, including documents originating from Batelco's vendors for the use of Batelco's technicians as well as documents informing and confirming the acceptance of the service delivery to the end-user);
  - b) Documents describing the processes by which the provision of broadband access is performed (if relevant, including documents originating from Batelco's vendors for the use of Batelco's technicians as well as documents informing and confirming the acceptance of the service delivery to the end-user);
  - c) Documents describing the handling of faults on active copper lines by Batelco (if relevant, including documents originating from Batelco's vendors for the use of Batelco's technicians);
  - d) Documents describing the relevant Information Systems implemented inside Batelco (e.g. for Batelco staff and/or vendors to know the quality of the line or the status of the line, for Batelco staff and/or vendors to handle an order, etc.);
  - e) Documents describing the current arrangements for Batelco's staff and contractors to access Batelco's sites.

---

<sup>17</sup> [http://www.batelco.com/inet\\_terms\\_conditions.asp](http://www.batelco.com/inet_terms_conditions.asp)

### **7.3 Ancillary service #1: provisioning of LLU-related specific information**

100. In Section 5.2 of this report, TRA has defined the general information relating to Batelco's local loop that should be made available, as soon as possible, free of charge<sup>18</sup>.
101. TRA anticipates that, in order for OLOs to define their strategy for LLU development, they will need to access more specific information from Batelco for each Service Node. This data must also be provided by Batelco to the OLOs<sup>19</sup>. The price at which this information should be provided will have to be determined at a later stage on the basis of costs incurred by Batelco. Batelco must not withhold this information if the price for that information is not settled at the time of the OLOs request or at the time that Batelco has the information is ready. The price may be recouped after the information has been provided to the OLO.
102. Based on a review of relevant Reference Offers in other countries, the following LLU specific information could be of relevance for OLOs and must be made available to OLOs by Batelco, if available:
  - a) The number of active lines;
  - b) The number of non-active lines (i.e. lines not supporting any service for any end user) with end to end connectivity ;
  - c) The geographical location of the Service Nodes (national address);
  - d) The average length of copper local loops (meters);
  - e) Power availability at each of Batelco's Service Nodes;
  - f) Service Node space availability;
  - g) Cable entry points (First manhole closest to the exchange) and duct capacity available;
  - h) General information on cable characteristics (e.g. diameter, results from quality tests that have been conducted, technical interference, control and spectral management plan);
  - i) Results of any xDSL tests.
103. Batelco must update this information on a quarterly basis and to provide it to OLOs on request.

### **7.4 Ancillary service #2: provisioning of LLU backhaul**

104. LLU backhaul provides capacity between an OLO's exchange equipment at a Batelco Service Node and an OLO's points of presence. There are likely to be various types of backhaul depending on the type of collocation employed by the OLO, and the type and location of the OLO's points of presence.

---

<sup>18</sup> This information is confidential and cannot be used by the OLO for any purpose other than an analysis and implementation of LLU. The information cannot be provided to any third party unless agreed to by Batelco or if required by law. Should the OLO wish to provide external consultants with the information for the purposes of advising it on LLU analysis and implementation it must seek Batelco's written permission, which must not be unreasonably withheld. Batelco may insist that the consultant enter into a non-disclosure agreement with the OLO and Batelco.

<sup>19</sup> As per foot note 18

105. OLOs may choose to self-provide backhaul by deploying fibre and connecting Service Nodes of Batelco.
106. OLOs may choose to purchase backhaul from either Batelco or another OLO.
107. However, overseas experience shows that there is a tendency, especially during the early stages, for OLOs to be reliant upon incumbent-provided backhaul solutions. The costs associated with civil works and laying fibre with uncertain economies of scale often form a barrier to entry for OLOs. Batelco must provide a cost-oriented backhaul offer (with a corresponding Service Level Agreement). In particular, OLOs must be able to receive multiple LLU backhauls to a single point of presence.
108. Furthermore, TRA is of the view that there should be no provision in Batelco's LLU RO that render the build-out of own infrastructure by OLOs uneconomical. Such impediments may include: restrictions relating to access to infrastructure (duct) from the manhole chamber closest to the exchange and the Optical Distribution Frame in the exchange to which an OLO may wish to connect a backhaul circuit; and restrictions placed upon OLOs prohibiting capacity sharing.

### **7.5 Ancillary service #3: provisioning of collocation**

109. TRA requires that, to the extent that there is sufficient space, all the options for collocation listed in Paragraphs 40 and 41 (except virtual collocation) must be made available by Batelco.
110. Since space may be scarce in a number of Service Nodes and there may be demand for this space from several OLOs, TRA believes that rules have to be set to ensure an efficient allocation of space between requesting OLOs.
111. Based on a review of international best practices, TRA requires that the following five rules for the efficient allocation of collocation space should be adopted into Batelco's LLU Service Description:
  - a) **First Come First Served rule:** This rule ensures that OLOs that ask for collocation space earlier are served first. TRA believes that any other rule for allocating space may slow down the development of LLU. As is the case in duct and civil works, the first OLO shall bear all the associated costs and shall be reimbursed by other OLOs coming afterwards on a pro rata basis.
  - b) **Use It or Lose It. By this rule:** if an OLO has been granted space but has not used this space after the specified reasonable period of time, the space will be released and re-allocated. This will prevent the inefficiencies created by hoarding space. TRA is of the view that an appropriate approach for implementing the "Use it or Lose it" rule is to consider that an OLO will lose its allocated space if no customer is connected to the OLO's equipment through LLU 3 months after the space being allocated to the OLO by Batelco. TRA also considers that the 3-month period may need to be reviewed in the course of LLU implementation since it also depends on the delivery time of ancillary services on which Batelco will commit.
  - c) **One single space allocated per OLO per Service Node.** Where space is scarce OLOs will be initially restricted to a single space. This restriction will be reviewed on an exchange-by-exchange basis to ensure proportionality. The definition and dimensions of a "space" will be determined through the field tests on the basis of the exchange equipment chosen by the OLOs.

- d) Batelco should rely on effective demand for site preparation and as a general rule it should not be required of Batelco to provide space in advance for all or part of its Service Node sites.
- e) If several collocation options are available, **the cheapest option should always be proposed by Batelco**. As a consequence, the co-mingling option should always be proposed, and then, if no space is available for this option, the dedicated room option should be proposed, and then if no space is available for this option, the shelter option should be proposed, and then if no space is available for this option, the distant collocation option should be considered.

112. TRA anticipates that there is a risk of inefficient allocation of space for the very first ordering of collocation sites by OLOs, in particular for attractive Service Node sites. TRA requires the following specific process for the very first collocation ordering:

- a) First, pursuant to a letter sent by TRA, OLOs will have two weeks to specify their orders for the sites for which they intend to place an immediate order.
- b) Batelco will determine for each Service Node site the best collocation option that will fulfil the demand within one month, based on orders received and will send OLOs the corresponding collocation prices.
- c) OLOs will have two weeks to confirm their order, based on the prices provided by Batelco. Confirmation will be accompanied by a non-refundable advance payment.

**Figure 14 - Proposed calendar for the space allocation specific process for the very first collocation ordering (for illustrative purposes only)**

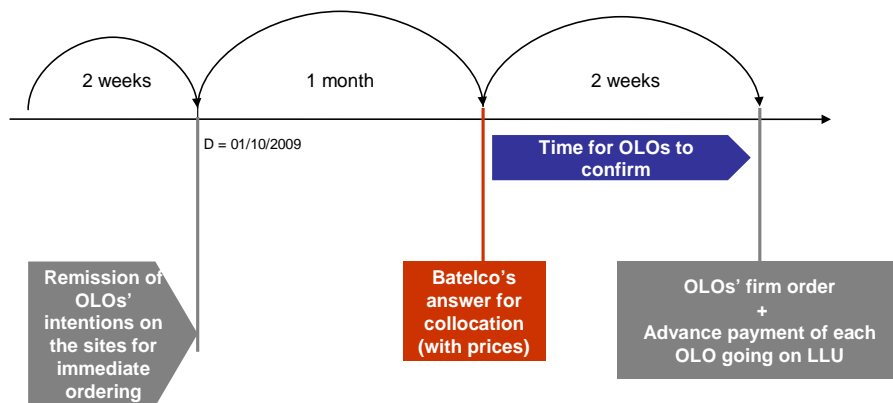

113. TRA shall require from Batelco the information about the Service Nodes during the very first collocation ordering and may undertake site visits if appropriate.

## 7.6 Relationships between end-users, OLOs and Batelco

114. In order to prevent any unnecessary relationship between the end-user and the incumbent, when services are provided to the end-user on the basis of LLU, some

countries<sup>20</sup> have introduced the possibility for end-users to sign a document that authorises their chosen OLO to perform all the necessary actions with the incumbent for having their line unbundled.

115. TRA considers that LLU should be transparent for end-users and is of the view that end-users do not need to have any contact with Batelco for having their line unbundled. Therefore, TRA believes that end-users may sign a document authorising an OLO to complete all the necessary actions with Batelco for having their line unbundled, including fixed number portability when available and as appropriate.
116. Furthermore, the consequences of terminating the contract, e.g. clearing current debts, with Batelco should not be a barrier to change from Batelco to an OLO. In other words the end user can change to the OLO without having to have discharged all existing debts to Batelco, although Batelco is still entitled to pursue payment of those debts through all legal channels.

### **7.7 Access Network Frequency Plan (ANFP)**

117. In 2003, UK's Ofcom defined the Access Network Frequency Plan (ANFP) (also called Interference Management Plan) as "a spectrum management plan for controlling interference, caused by cross talk, within a metallic access network". The ANFP is a major document for LLU implementation as it enables OLOs to deploy services in a predictable and reliable manner. It is specified by a list of Power Spectrum Density masks applicable at a number of defined points in the access network. The ANFP is less constraining for OLOs than a list of allowed technologies.
118. TRA requires that Batelco should release the ANFP for the field tests at least 14 days prior to the start of the field test in the Kingdom of Bahrain. This ANFP will then be reviewed in a working group hosted by TRA with interested OLOs and possibly manufacturers/suppliers if required.

### **7.8 Bulk Migration**

119. A bulk migration is the multiple migrations of Bitstream or Wholesale DSL customers to LLU. Bulk migration is transparent for end-users and allows OLOs to migrate a large number of customers more quickly.
120. While TRA acknowledges that bulk migration has helped in the take-up of LLU in many European countries, such as France, the United Kingdom or Ireland, it does not exist in countries like Luxembourg, Cyprus or Malta. Since the number of Wholesale DSL and Bitstream customers in Bahrain is not so large and there is a significant potential to unnecessarily complicate the implementation of LLU in Bahrain, TRA considers that the benefits associated with bulk migration are likely to be minimal and as such TRA will not mandate it at present.

### **7.9 Forecasts**

121. TRA has noticed issues related to forecasts that have arisen in the context of the Bitstream product provided by Batelco. For the provision of this product, Batelco requires OLOs to forecast their numbers of broadband users.

---

<sup>20</sup> See for example, France, Ireland or the United Kingdom

122. With LLU, OLOs may be required to provide some forecasts about their LLU plans to Batelco to help Batelco anticipate and plan associated activities.
123. Since the budgeting for equipment and associated internet connectivity remains the responsibility of the OLO, TRA believes that forecasts are only necessary to assist in the organisation of work to be done in the future and for budgeting jumpers and backhauls if necessary.
124. TRA is of the view that forecasts should not unduly constrain OLOs. Such forecasts will be only provided for planning purposes and will not have any penalty implications on OLOs.
125. Based on international practices<sup>21</sup>, TRA will require that OLOs should only provide forecasts about their future orders for LLU services:
  - a) for the next 12 months for orders relating to collocation (including type and capacity of backhaul requested) and tie cables;

## **7.10 Service Level Agreements (SLAs)**

126. Overseas experience shows that there are various possibilities to put competitors at a disadvantage by means of quality discrimination. As the quality of a service is particularly difficult to observe for a regulator, regulators have imposed an obligation to offer service level agreements (SLAs) and periodically report Key Performance Indicators (KPIs) to the regulator and where appropriate to OLOs (e.g. on the website of the operator providing LLU)<sup>22</sup>. Such KPIs could be reported for services provided to OLOs as well as for self-provided services, to monitor compliance with the non-discrimination obligation<sup>23</sup>.
127. TRA is of the view that Service Level Agreements (SLAs) with associated penalties ensure that the provision of the LLU product will be done with a known level of quality of service.
128. In light of the encountered implementation difficulties in Europe, such as the complexity of the Bow Wave Process in the UK<sup>24</sup> or the ongoing discussion on the collocation process in Ireland, TRA requires that at a minimum the following parameters should be set for SLAs:
  - a) For Full LLU line delivery, validation time and delivery time;
  - b) For ancillary service, validation time and delivery time;
  - c) For fault clearance, validation time and repair time.

---

<sup>21</sup> See, for example, France Telecom's Reference Unbundling Offer

<sup>22</sup> See 5.2.4.5 Quality discrimination, in Revised ERG Common Position on the approach to appropriate remedies in the ECNS regulatory framework - Final Version May 2006

<sup>23</sup> E.g. Indicateurs de qualité de service pour le dégroupage et les marchés aval – Résultats du mois de décembre 2008 – Orange : [http://www.francetelecom.com/fr\\_FR/groupe/reseau/documentation/att00001745/ReportingspourARCEP12-08.pdf](http://www.francetelecom.com/fr_FR/groupe/reseau/documentation/att00001745/ReportingspourARCEP12-08.pdf)

<sup>24</sup> <http://www.ofcom.org.uk/static/archive/Oftel/publications/broadband/llu/bowp0201.htm>

For the purpose of this paragraph “validation time” refers to the time taken by Batelco between receiving the order or fault notification and the point of final assessment of the validity of that order or fault notification.

129. When reviewing the LLU Service Description TRA will set the value for these parameters of SLAs on the basis of the LLU process assessment that will be reviewed with Batelco and on the basis of the opinion of respondents of the Consultation Document.
130. TRA recognizes that in the early stage of LLU deployment, it may be difficult for Batelco to achieve SLAs because of the fact that some processes may be new to Batelco. As a consequence, TRA proposes that Batelco shall publish within its RO target SLAs and associated penalties. TRA will review the value for these parameters of SLAs on the basis of the LLU process assessment that will be reviewed with Batelco and on the basis of the opinion of respondents of the Consultation Document (see paragraph above). Furthermore, Batelco shall publish on a monthly basis corresponding KPIs, based on which final SLAs will be defined, taking into account, whenever appropriate, benchmark information. Final SLAs will be set within 6 months from the date of LLU being commercially launched.<sup>25</sup>

---

<sup>25</sup> See TRA Access Order, 14 September 2009 (Reference MCD/09/09/065)

## 8 Monitoring the development of LLU

### 8.1 Introduction

131. The four preceding sections have discussed the implementation of LLU before its commercial launch. This section addresses the issues relating to monitoring LLU.

### 8.2 Publication of Key Performance Indicators (KPIs)

132. In order to ensure both compliance with non-discrimination obligations and that the services provided to OLOs are fit-for-purpose, TRA requires Batelco to periodically report Key Performance Indicators (KPIs) to the Regulator (as part of the regulatory requirements relating to the Quality of Service) and where appropriate to OLOs (e.g. on the website of the operator providing LLU).
133. TRA observes that the current minimum set of KPIs in Europe<sup>26</sup> needed to monitor the application of the non-discrimination obligation and the effectiveness of Service Level Agreements and to allow the identification of any persistent or new problems in the context of LLU is the following:
- a) Ordering
  - b) Delivering
  - c) Fault repair
134. As a consequence, TRA is of the view that the minimum set of KPIs that should be measured on a monthly basis and published by Batelco on its website for LLU<sup>27</sup> is the following:
- a) Average delivery time (in days, working) for
    - i. active lines
    - ii. non-active lines
    - iii. all lines (active and non-active lines)
  - b) % of delivery before or at the committed date for
    - i. active lines
    - ii. non-active lines
    - iii. all lines (active and non-active lines)
  - c) % of faults cleared in less than 'x' (to be proposed by Batelco and corresponding with its own retail processes) hours for all active and non-active lines

---

<sup>26</sup> Report on ERG best practices on regulatory regimes in wholesale unbundled access and Bitstream access, ERG (07) 53, page 16 & 17.

<sup>27</sup> An extract of KPIs for residential offers published by the French Incumbent (France Telecom) could be found in Annex 1

### **8.3 Publication of a LLU scorecard**

135. In order to follow the development of LLU and to provide market data to various stakeholders, TRA intends to develop and publish on its website a LLU scorecard. Similar scorecards are generally made available by regulators<sup>28</sup>. The following three indicators will be tracked and published by TRA on a quarterly basis:
- a) The number of unbundled lines;
  - b) The number of unbundled MDFs;
  - c) A map of the geographical coverage of LLU<sup>29</sup>.

### **8.4 Creation of working groups hosted by TRA**

136. Despite LLU field tests taking place in October 2009 and the work that will be undertaken by TRA and its consultants, Batelco and OLOs prior to the commercial launch of LLU, it will not necessarily be sufficient to address all the operational issues around LLU. Consequently, TRA is of the view that a Working Group on LLU Operations and Service Schedules should be established and meet on a regular basis.
137. The goals of this Working Group will be to analyze and refine any existing processes and SLA/KPI measures to suggest appropriate amendments to the LLU RO as necessary.

---

<sup>28</sup> See e.g. ARCEP, Ofcom and the EC.

<sup>29</sup> See e.g. <http://www.arcep.fr/index.php?id=34>

## 9 Operational or Structural Separation of the Local Loop

138. TRA is aware that some regulators are looking at alternative models of operational or structural separation, in which the access network is separated from the core network so that equivalent access services can be offered to all competing network and service providers<sup>30</sup>. Such a model ensures the absence (or significant reduction) of incentives to discriminate between the incumbent's and the OLOs' end-users.
139. TRA considers that this model may become important in the future, particularly with the moves towards next generation IP networks and the convergence of services (e.g. between fixed and mobile, and between telecoms and broadcasting) or if the implementation of LLU and other products (such as Bitstream) on the basis of the current setup of Batelco proves to be hindered by incentives to discriminate against OLOs.
140. TRA proposes to continually monitor and evaluate the status of LLU implementation in Bahrain and, where it determines the existence of anti-competitive practices by Batelco such that LLU deployment is obstructed, it may thereafter consider and adopt an appropriate approach to separation. TRA does not consider structural separation appropriate at this time but may consider it in the future.

---

<sup>30</sup> See the creation of Openreach in January 2006 in the United Kingdom, the current discussions in Poland between Batelco TP and the NRA and discussions between ComReg and Eircom in Ireland in late 2007.

## 10 Key milestones of the LLU implementation phase

141. In its Determination on Wholesale broadband markets<sup>31</sup>, TRA has identified the following market failure: Batelco is dominant in the wholesale physical network infrastructure access market in the Kingdom of Bahrain.
142. TRA hereby orders Batelco to provide LLU under Article 3.5 of the Access Regulation, after having conducted, pursuant to Article 3.7 of the Access Regulation issued on 30 April 2005, an assessment<sup>32</sup> of whether such an Access Obligation for LLU is no more than is appropriate and necessary to address the market failure identified by TRA, taking into account:
- a) the technical and economic viability of installing competing facilities, in light of the level and rate of market development;
  - b) the feasibility and efficiency of providing the form of access, particularly in light of the available capacity; and
  - c) TRA's duty to safeguard and encourage the long-term development of competition and the long-term interests of end-users.
143. As a consequence, pursuant to Article 5 of the Access Regulation issued by TRA on 30 April 2005, Batelco must submit its Reference Access Offer to TRA for approval, within two (2) months of the issuance of the Access Order, to which this Implementation Order is an integral part.
144. TRA hereby requires the following key milestones for the LLU implementation phase:
- a) The LLU-related general information existing at the date of the Access Order must be made available by Batelco to OLOs on simple written request by no later than 14 days after the issuance of the Order<sup>33</sup>. For the filed tests, Batelco must make available all related information to the participating OLOs no later than 14 days prior to the start of the field test.
  - b) Batelco shall take all appropriate actions so that the LLU field test experimentations (see Section 4.3) can begin by no later than 11 October 2009. The field test experimentations shall last for at least six (6) weeks.
  - c) Batelco shall submit its LLU Reference Offer Service Descriptions to TRA for review and approval or ordering within 2 months of the Dominance Determination.
  - d) The commercial launch is not later than 14 days from the date TRA approves or orders Batelco's LLU SD.

---

<sup>31</sup> TRA, Dominance Determination in Wholesale Broadband Markets, 14 September 2009. This information is confidential and cannot be used by the OLO for any purpose other than an analysis and implementation of LLU. The information cannot be provided to any third party unless agreed to by Batelco or if required by law. Should the OLO wish to provide external consultants with the information for the purposes of advising it on LLU analysis and implementation it must seek Batelco's written permission, which must not be unreasonably withheld. Batelco may insist that the consultant enter into a non-disclosure agreement with the OLO and Batelco.

<sup>32</sup> TRA, Study on the Regulation of Wholesale Broadband Markets, Annex C to this Access Order, 14 September 2009

<sup>33</sup> TRA, Access Order relating Unbundling Local Loop, Bitstream and Wholesale DSL, 14 September 2009



هيئة تنظيم الاتصالات  
Telecommunications Regulatory Authority

## **Annex 1 to the Implementation Report:**

### **Appropriate approach for the implementation of Local Loop Unbundling (LLU) in the Kingdom of Bahrain**

#### **A report on the consultation responses**

14 September 2009

**Purpose:** To summarise and address the industry's comments on TRA's proposed approach for the implementation of Local Loop Unbundling (LLU) in the Kingdom of Bahrain

## Table of contents

List of Acronyms.....	57
1 Introduction.....	58
2 Defining the scope of LLU that would be appropriate to Bahrain.....	59
3 Capacity building of the industry prior to LLU implementation.....	61
4 Selecting the principles for setting LLU rates on an interim basis .....	68
5 Anticipating the main operational issues that could occur during the initial LLU implementation phase.....	71
6 Monitoring the development of LLU .....	86
7 Operational or Structural Separation of the Local Loop.....	90

# List of Acronyms

ANFP	Access Network Frequency Plan
CPS	Carrier Pre Selection
DSL	Digital Subscriber Line
KPI	Key Performance Index
LLU	Local Loop Unbundling
LS	Line Sharing
MDF	Main Distribution Frame
MSAN	Multi-Service Access Node
NGA	Next Generation Access
NFWS	National fixed wireless services
Ofcom	Office of Communications (UK)
OLO	Other licensed operator
RFP	Request For Proposal
RO	Reference Offer
ROI	Return On Investment
SLA	Service Level Agreement
SLU	Sub-Loop Unbundling
SMP	Significant market power
SRMR	Strategic and Retail Market Review
TRA	Telecommunications Regulatory Authority of the Kingdom of Bahrain
UK	United Kingdom
WDSL	Wholesale Digital Subscriber Line

# 1 Introduction

1. The purpose of this document is to summarise and address the comments received on TRA's draft Appropriate Approach for the Implementation of Local Loop Unbundling ("LLU") in the Kingdom of Bahrain issued on 26 March 2009 (Ref. MCD/03/09/020) (the "March 2009 Consultation Document") .
2. LLU is a process by which copper local loops are connected to the networks of Other Licensed Operators ("OLOs") and are used for their own broadband services (e.g. double play services such as Internet and Voice, or triple play services such as Internet, Voice and Television) and other connectivity services. LLU can also be used to provide fixed telephony services only, although in practice it is used primarily to provide broadband and connectivity services.
3. The March 2009 Consultation Document:
  - a) described the LLU product;
  - b) defined the scope of LLU deemed appropriate for Bahrain;
  - c) outlined the different capacity building actions necessary to facilitate the adoption and uptake of LLU by market players;
  - d) discussed the principles used for setting LLU prices on a transitory basis;
  - e) identified the main operational issues that could occur with the implementation of LLU, drawing on LLU experience in other countries, and proposed options to mitigate these prior to the implementation of LLU;
  - f) described the actions TRA will undertake to monitor the development of LLU; and
  - g) discussed the relevance of operational or structural separation of the local loop in the Kingdom of Bahrain in the context of LLU.
4. In developing this approach, TRA had considered approaches followed by other regulators and had taken into account the specific characteristics of the local market, including the relative size of Bahrain's telecommunications sector.
5. TRA received responses from Bahrain Telecommunications Company B.S.C. ("Batelco"), MTC-Vodafone Bahrain B.S.C. ("Zain"), Kalaam Telecom B.S.C. ("Kalaam Telecom") and Lightspeed Communications W.L.L. ("Lightspeed"). The response from 2Connect was received after the closing date of the consultation and therefore was not considered but published by TRA for the benefit of the industry..
6. In this report, TRA considers these responses to reach its conclusions.
7. For clarity purposes, before addressing each of the 25 questions, this document briefly summarises TRA's views in the March 2009 Consultation Document and then addresses the comments received and TRA's conclusion.

## 2 Defining the scope of LLU that would be appropriate to Bahrain

### Question 3.1

Do you agree with TRA's proposition to implement only Full LLU for the time being? Please elaborate.

#### The March 2009 Consultation Document

8. TRA was of the view that in order to ensure the effective and smooth implementation of LLU, only Full LLU and not Line Sharing ("LS") should be implemented for the time being as far as the simplicity, the benefits to end-users, OLOs' points of view, international experience and pricing are concerned.

#### Responses to the March 2009 Consultation Document

9. All respondents agree with TRA's view.
10. Zain comments that LS would create confusion for end-users and would introduce complexity for fault repair and for number portability.
11. Based on the European experience, Lightspeed notes that LS is not the preferred option by new entrants and is not a prerequisite for the successful implementation of LLU. Also, Lightspeed adds that it is preferable for the relationship between end-users and the incumbent to cease if the end-user has switched to an OLO. Finally, Lightspeed emphasises the importance of fixed number portability for LLU.
12. Even though Batelco is of the view that it is not appropriate and necessary to implement LLU at this time for the reasons set out in its other answers, Batelco agrees with TRA's view that only Full LLU should be implemented.

#### TRA analysis and conclusion

13. Considering respondents' comments, TRA remains of the view that only Full LLU is to be implemented for the time being.

### Question 3.2

Do you agree with TRA's proposition not to implement SLU for the time being?

#### The March 2009 Consultation Document

14. Taking into consideration the advantages of SLU compared to LLU in terms of DSL performance and the questionable viability of SLU due to the limited economies of scale, TRA was of the view that the additional requirement to implement SLU would unnecessarily complicate the implementation of LLU at this time and offer few benefits.

## **Responses to the March 2009 Consultation Document**

15. All respondents agree with TRA's proposition not to implement SLU.
16. Lightspeed adds that, after the successful implementation of Full LLU, this proposition may be reviewed in the future.
17. While agreeing, Batelco underlines that SLU is even less appropriate than LLU given the prospect of NGA.

## **TRA analysis and conclusion**

18. Having considered the general acceptance of respondents, TRA remains of the view that it is not necessary to implement SLU for the time being.

### **Question 3.3**

Do you agree with TRA's proposition that non-active lines for which there is capacity at the main network level and at the distribution level should be unbundled? Please elaborate.

## **The March 2009 Consultation Document**

19. TRA's view was that the scope of lines that might be unbundled should be both active and non-active lines to the extent that there is capacity available at the main network and at the distribution network level.

## **Responses to the March 2009 Consultation Document**

20. All respondents agree with TRA's proposition.
21. Zain specifies that there should be a maximum distance between the customer premises and the distribution point beyond which OLOs could be in a position to deploy the final drop themselves.
22. Lightspeed underlines that TRA's proposition is consistent with the non-discrimination principle since Batelco can use these non-active lines for its retail services. Lightspeed believes that TRA's approach will increase the Internet penetration level in the market and will help in establishing efficient and effective competition in all sub-markets. Lightspeed also insists on the fact that TRA should always closely supervise Batelco's market behaviour and study carefully any order refused by Batelco on the basis that capacity is not sufficient. Finally, Lightspeed considers that Batelco should provide without any delay the complete up-to-date information for all active and non-active lines free of charge.
23. Batelco agrees with TRA's proposition and states that active lines and non-active lines should be unbundled "subject to technical feasibility".

## **TRA analysis and conclusion**

24. Referring to Zain's comments, TRA will endeavour to determine with the industry, in the course of implementation of LLU, what should be the maximum distance between the

distribution point and the customer premises beyond which Batelco is not obliged to connect the customer premises to its copper local loop when a customer premises is not served by a final drop. TRA rejects the proposition by Zain that, beyond such a maximum distance, OLOs would deploy the final drop themselves. TRA determines that Batelco should have sole responsibility for the deployment of its copper local loop.

25. With respect to Lightspeed's comments, TRA notes that the provision of information related to active and non-active lines is discussed later in this document.
26. Regarding Batelco's comments, TRA notes that the concept of "technical feasibility" is not clear enough. TRA is of the view that Batelco should always fully justify why an order related to non-active lines is rejected. If TRA is made aware by OLOs that a high number of orders related to non-active lines are rejected by Batelco, TRA will investigate whether these rejections are justified, fair and proportionate.
27. As a consequence, having considered the views of respondents, TRA remains of the view that both active lines and non-active lines should be allowed to be unbundled to the extent that there is capacity both at the main network and at the distribution network level.

### **3 Capacity building of the industry prior to LLU implementation**

#### **Question 4.1**

Do you agree with TRA's proposition that the list of MDFs with their category of size and the location of these MDFs on a map (except the ones for which valid national security reasons prevent their location being made public) with their coverage area should be made available free of charge by Batelco on simple request subject to a confidentiality agreement signed by the OLO as soon as possible after the issuance of the Order? Please elaborate.

#### **The March 2009 Consultation Document**

28. TRA's view was that a list of MDFs with their category of size and their location on a map with their coverage area should form a part of the Reference Offer and should be made available to OLOs as soon as possible after the issuance of the Order relating to Unbundling Local Loop, Bitstream and Wholesale DSL on simple request, subject to a confidentiality agreement, where reasonably required by Batelco.

#### **Responses to the March 2009 Consultation Document**

29. All OLOs (Kalaam Telecom, Zain, Lightspeed) agree with TRA's view on the list of information that should be made available by Batelco.
30. Kalaam Telecom considers that it will allow OLOs to base their plan on solid information.
31. Zain believes that this information should not be provided free of charge, firstly, because maps are expensive and, secondly, because maps can be used not only for network planning but also for marketing future services.
32. Lightspeed stresses that Batelco should not delay in providing the complete and updated information due to the importance of time for OLOs to design their business

operations. Lightspeed underlines also that only TRA should decide whether information about some MDFs cannot be made public for security reasons.

33. Batelco disagrees with TRA's proposition. Batelco explains that all information on Service Nodes is confidential and commercially sensitive. Batelco does not support an approach where it is forced to provide information prior to testing and placing of orders. Batelco therefore proposes a review of the information to be provided, which will be supplied after testing and on receipt of a valid LLU request. Batelco adds that the provision of such information should not be free of charge.

### **TRA analysis and conclusion**

34. Referring to Zain and Batelco's comments on a possible charge to obtain relevant information, TRA observes that the cost of preparing and providing the maps is not a significant cost. It is related to the implementation of LLU and Batelco should be allowed to recover the efficiently incurred cost. TRA notes that very similar information was provided by Batelco to TRA in early 2009 and is to a large extent already available at Batelco.
35. With respect to Lightspeed's comments on the fact that TRA should decide whether information about some MDFs cannot be made public for security reasons, TRA would like to specify that these sites are known by TRA. TRA is also of the view that they will not, at the time being, be subject to LLU orders.
36. Regarding Batelco's comments on the fact that this information is confidential and commercially sensitive, TRA reiterates that it is of the view that this information should be made available subject to a confidentiality agreement. TRA believes that this information is confidential but not commercially sensitive as it is strictly related to the purpose of enabling OLOs to place informed LLU orders in accordance with their network roll-out plan. TRA also reiterates that this is consistent with international practice.
37. Regarding Batelco's comments stating that it should not provide this information prior to testing and placing of orders, TRA believes that, contrary to other types of information related to Batelco's local loop, the list of MDFs with their category of size and their location on a map with their coverage area is extremely important for OLOs. It will enable them to define their business plans and to understand the economics of LLU in the specific context of Bahrain. TRA observes that all OLOs support TRA's view on this point. As a consequence, it is critical for OLOs to get this information as soon as possible in order to be ready to place their orders when LLU is implemented. Since this information is already available in Batelco, TRA sees no reason to unnecessarily delay its provision to OLOs. Any delay would only serve to hinder the rollout of LLU in the Kingdom of Bahrain.
38. Having considered the views of respondents, TRA remains of the view that this information (list of MDFs with their category of size and their location on a map with their coverage area) should be part of the Reference Offer and made available to OLOs as soon as possible after the issuance of the Order on simple request, subject to a confidentiality agreement and free of charge.
39. For the avoidance of doubt, Batelco will be allowed to recover the efficiently incurred costs of preparing and providing such information.

#### **Question 4.2**

Do you agree with TRA's proposition to organise LLU field tests? Do you agree with the proposed timing? What is your opinion on the site selection proposition? What is your opinion on the OLOs' selection proposition? Please elaborate.

Do you think that other collocation options than the two currently proposed should be envisaged for the LLU field tests?

If as an OLO you are interested in participating in LLU field tests, please specify to which of your network sites backhaul would have to be provided by Batelco.

#### **The March 2009 Consultation Document**

40. TRA was of the view that substantial benefits from LLU field tests can be expected for the incumbent, for OLOs and for TRA itself, since they should enhance LLU knowledge for all parties, speed up the commercial launch of LLU to the benefit of end-users, enable the anticipation of operational issues and ease discussions between all parties involved.
41. TRA was of the view that these field tests should occur in mid-2009 and should last a minimum of 2 months with a minimum and maximum number of end-users involved in the participating OLOs' tests.
42. TRA proposed that the two most normally requested collocation options, based on international experience, should be considered during these trials: the co-mingling option and the dedicated room option.

#### **Responses to the March 2009 Consultation Document**

The following subjects have been mentioned by respondents:

- *Field tests proposition:*
43. All OLOs (Kalaam Telecom, and Lightspeed) agree with TRA's proposition for field tests.
  44. Batelco submits that the scope of the suggested field tests is not clear and request more precision from TRA. Batelco supposes that the goal of field tests is purely to demonstrate the capability of the copper network from one Service Node using MSANs. In addition to field tests, Batelco submits that there should also be a pilot test with one single operator who is committed to LLU to ensure effective processes are adopted and LLU can be provisioned successfully. According to Batelco, this pilot test should run for 6 months and allow OLOs to get customers and test processes and it cannot begin before the RO prices are finalised.
  45. Batelco adds that resources may not be readily available to support more than one OLO for the period of the trial. Batelco refers to precedent trials involving only one OLO.

- *Field tests timeframe*

46. Kalaam Telecom suggests that the timeframe is too short as it does not allow OLOs that are not up-to-date to enter the market.
47. Batelco submits that the proposed timeframe is too ambitious for three reasons:
- field tests need to occur once the approach and the drafting of processes is agreed in order to ensure that the test is focused on the selected option and that no efforts are wasted on non-viable options;
  - It can take OLOs up to 8 weeks for the procurement, selection and delivery of equipment based on Batelco's experience;
  - the site preparation requires time in order to arrange for the necessary ancillary services.
- *Collocation options*
48. Kalaam Telecom submits that the two collocation options mentioned are the most practical choices.
49. Batelco submits that only distant collocation should be considered for the following reasons:
- a) Batelco considers that there are many sites close to Batelco's Service Nodes that could be suitable for distant collocation;
  - b) Batelco believes that there is a serious physical space issue – at least for some of the MDFs that are likely to be in demand by OLOs. Batelco estimates that, considering all the Service Nodes, there would be congestion issues in approximately half of these (compared with the sample that TRA chose for the site visits);
  - c) Batelco believes that distant collocation can give equal and fair opportunity to all OLOs irrespective whether they come first or last;
  - d) Batelco believes that space allocation and site access processes are no more necessary with distant collocation;
  - e) Batelco believes distant collocation can eliminate barriers for OLOs building own backhaul or own access network.
- *Backhaul*
50. Kalaam Telecom submits that backhaul should be fibre-based.
51. Lightspeed suggests that backhaul such as dark fibre or access to Batelco's ducts should be tested during the field tests.
- *Other comments*
52. Kalaam believes that TRA should specify the number of sites available for collocation, the number of spaces that can be provided and the selection process. Kalaam proposes that the selection process should be based on the OLOs' capabilities to provide the basic service with a clear view of the future plan.
53. Lightspeed believes that field tests should be free of charge.

## **TRA analysis and conclusion**

- *Field tests proposition*

54. With respect to Batelco's comments, TRA notes that the description of field tests was detailed in its Consultation Document (paragraphs 57 to 63), where it is explained that the goal of field tests is not purely to demonstrate the capability of the copper network from one Service Node using MSANs (which is what Batelco states) but "to build a dedicated LLU task force, to elaborate and refine the relevant provisions of the Reference Offer and the associated operational processes, and to learn how to work with OLOs" (March 2009 Consultation Document). As a consequence, the concept of field tests proposed by TRA is close to the concept of pilot test proposed by Batelco.
55. Regarding the resources dedicated to the field tests, TRA believes that the incremental resources required for the additional OLO taking part in field tests is very low, since field tests will occur in the same MDFs. Costs incurred by Batelco as part of the preparation of sites will be recovered by Batelco as approved or ordered by TRA. TRA notes that when LLU is launched, more than one OLO may be interested in LLU, and therefore Batelco will have to make sufficient resources available to provide this regulated service. Since field tests will tend to reflect the way that LLU will work once commercially launched, resources should therefore be available for field tests as well.
56. Having considered OLOs' wishes to take part in field tests and having considered Batelco's comments, TRA remains of the view that such field tests should occur. TRA is, however, mindful of the resources that Batelco will have to make available and, given the timeframe proposed for the field tests, TRA proposes to focus on only one collocation option, namely comingling, in two identified Service Node.
  - *Field tests timeframe*
57. Regarding Kalaam Telecom and Batelco's comments stating that the field tests timeframe is too tight for OLOs to acquire equipment, TRA acknowledges that OLOs may need more time to discuss their requirements with vendors. Batelco states that up to 8 weeks can be required by OLOs for equipment procurement, selection and delivery. However, TRA is of the view that because the Consultation Document, which was published in late March 2009, discussed the possibility of having field tests, this means that OLOs were in a position to begin discussions with vendors about 6 months before the start of field tests. TRA acknowledges that OLOs cannot purchase the equipment before field tests are confirmed (i.e. before the Order is issued) but considers that they can discuss their requirements with vendors. As a consequence, TRA estimates that 4 weeks after the issuance of the Order is largely sufficient for OLOs to acquire equipment but that 2 weeks may not be sufficient.
58. Regarding Batelco's comments on the fact that field tests should occur once processes are agreed so that no efforts are wasted, TRA disagrees with Batelco because the goal of field tests is to help in defining appropriate processes and testing them.
59. Regarding Batelco's comments on the fact that the site preparation requires time in order to arrange for the necessary ancillary services, TRA considers that it will be important to choose 2 sites almost ready to receive field tests. TRA conducted site visits in January and is of the view that some sites could very quickly accommodate field tests.
60. Having considered respondents' views, TRA is of the view that the start of field tests should occur no later than 4 October 2009. TRA reminds that the experience acquired by OLOs during field tests will be shared in a Working Group.
  - *Collocation options*

61. TRA disagrees with Batelco's view that only distant collocation should be considered. Based on its review of international implementations of LLU, TRA is of the view that distant collocation is the least preferred option and usually the most expensive one. More precisely, TRA disagrees with Batelco's points (a), (b) and (c) and believes that points (c) and (d) raised by Batelco do not outweigh the benefits of the co-mingling and dedicated room options:
- With respect to (a) above, TRA is of the view that the availability of sites close to Batelco can vary significantly from one Service Node to another.
  - With respect to (b) above, TRA reminds that it reviewed in January 2009 13 of Batelco's sites (out of around 50) and it is of the view that only one or two Batelco's Service Nodes could have physical space issues. TRA acknowledges that it mainly visited large sites but TRA is of the view that OLOs will mainly focus on large sites, at least in the early stages of LLU deployment.
  - With respect to (c) above, TRA disagrees with Batelco: distant collocation cannot offer equal and fair opportunity as well, since the number of possible sites close to Batelco's Service Nodes can be very limited.
  - With respect to (d) and (e), TRA agrees with Batelco but is of the view that international experiences show that other collocation options such as co-mingling or dedicated room are much more efficient and cost-effective.
62. Having considered respondents' views, TRA remains of the view that the co-mingling option should be tested during field tests.
- *Backhaul*
63. Having considered respondents' views, TRA is of the view that fibre-based backhauls, such as dark fibre, should be preferred for field tests. TRA is of the view that Lightspeed's suggestion to use Batelco's duct access is not suitable for field tests because this option may take too long to be implemented.
- *Other comments*
64. Regarding Kalaam Telecom's comment, TRA is of the view that, given the number of answers it has received up-to-now regarding field tests, all OLOs that wish to will be able to take part in field tests with the co-mingling option. As TRA proposes now not to pursue the dedicated room option, there is no issue with the selection process to be defined.
65. TRA wishes to clarify that it proposed that field tests should be free of charge, which implies that the costs incurred by Batelco should be included in a cost category called "LLU implementation costs" that will be recovered by Batelco. TRA notes that OLOs will have to incur costs for the procurement of equipment. This ensures that only serious candidates will take part in field tests.
66. Having considered the views of respondents, TRA is of the view that these field tests should occur from 4 October 2009 and should last a minimum of 6 weeks with at least 10 end-users and a maximum number of end-users equal to 50 involved in the participating OLO's tests (the respondents have not commented on these figures). TRA concludes that one of the two most normally requested collocation options based on international experience should be considered during these trials: the comingling option in the identified Service Node. TRA concludes that field tests be free of charge but that the costs incurred by Batelco be included in a cost category called "LLU implementation costs" that will be recovered by Batelco. The backhaul will be fibre-based backhaul. Based upon the information obtained from OLOs and Batelco during the November

2008 interviews, and taking into account space and appropriate backhaul availability, and site visits completed by TRA in Batelco's exchanges in early 2009, TRA has determined that the sites best suited for the Field Tests are Manama and Seef Service Nodes respectively referred to by Batelco as MAN and SEF.

**Question 4.3:**

Do you agree with TRA's proposition to organise capacity building workshops on the LLU offer (to be included in the RO) prior to LLU implementation? What is your opinion on the proposed agenda and timing of these workshops?

**The March 2009 Consultation Document**

67. TRA was of the view that it would be useful to organise workshops on commercial issues, type of services and technical/operational issues at the beginning of the third quarter of 2009.

**Responses to the March 2009 Consultation Document**

68. All respondents agree with TRA's proposition to organise capacity building workshops on the LLU offer.
69. Kalaam Telecom emphasises that it should cover best operational practices.
70. Lightspeed emphasises that the proposed agenda and timing of these workshops should be fixed and should address all issues resulting from the implementation of Full LLU.
71. Finally, Batelco stresses that the proposed timing for these workshops is too early and that the timetable of 3 days for such a workshop is too long (Batelco proposes 1.5 days). Batelco explains that the workshop can only occur when all legal terms, procedures and processes are agreed with TRA.

**TRA analysis and conclusion**

72. Regarding Batelco's comments on the proposed timeframe for these workshops, TRA reminds that the Access Regulation requires that the Reference Offer be developed within 2 months after the issuance of the Order. Considering the time required for TRA to review this Reference Offer, TRA proposes that these workshops take place one (1) week prior to the Launch of LLU<sup>1</sup>.
73. Regarding Batelco's comments on the duration of the workshop, TRA remains of the view that 3 days would be necessary. However, if it appears during the preparation of the workshop that less than 3 days would be necessary, TRA will adjust the duration to best meet participants' expectations.

---

<sup>1</sup> The exact workshop dates will be dependent on the progress of the LLU project and TRA will update the industry regarding the occurrence of such workshops.

74. Having considered the views of respondents and considering the fact that the industry welcomes such workshops, TRA will organise a workshop on commercial issues, type of services and technical/operational issues. This workshop should occur one (1) week prior to the Launch of LLU<sup>2</sup>.

#### **4 Selecting the principles for setting LLU rates on an interim basis**

##### **Question 5.1**

Do you agree with TRA's proposition to determine Full LLU prices on an interim basis?  
Please elaborate.

##### **The March 2009 Consultation Document**

75. TRA was of the view that a combination of two approaches should be used to establish a plausible range from which the initial interim prices for LLU services will be set. The first approach consists of analysing Batelco's cost information currently available and the second consists of benchmarking.

##### **Responses to the March 2009 Consultation Document**

76. All OLOs responding to this question (Kalaam Telecom, and Lightspeed) agree with TRA's view.
77. Zain highlights that the LLU price should not be set at too low a level to make sure that investment from NFWS operators is protected. In particular, Zain explains that the return on investment ("ROI") has not been achieved yet by NFWS operators. As a consequence, Zain proposes to set the LLU price at a level equivalent to cost incurred by NFWS operators. Zain explains that if the price is too low, then it will not make sense to invest in Wimax as long as LLU can provide the same services or maybe even better at lower cost.
78. Lightspeed considers that tariffs should be fair and benchmarked against international standards. Lightspeed also underlines that pricing rules for local loops should foster fair and sustainable competition and that there should not be an unfair discrepancy between the prices of wholesale services and the prices of retail services of the incumbent.
79. Batelco recommends on the contrary that proper existing information needs to be compiled on a fair and reasonable pricing basis. According to Batelco, using a benchmark on an interim basis is likely to be problematic because it:
- (a) "is usually the lowest ranked pricing option of the spectrum of decisions which can be reached by a regulator;
  - (b) sacrifices possible short term implementation timing gains for the benefits of carrying out a reasonable and measured costing process using the most up-to-date costing information;
  - (c) may create distortions in the wholesale market once costing work is completed;

<sup>2</sup> The exact workshop dates will be dependent on the progress of the LLU project and TRA will update the industry regarding the occurrence of such workshops.

- (d) fails to take into account local circumstances, bearing in mind there is no regional market which has undertaken benchmarking;
- (e) does not take into account that tariff rebalancing as [not] taken place;
- (f) may not take exchange rate fluctuations into account;
- (g) does not take into account that LLU has been in place for a number of years in benchmarked jurisdictions”.

80. Batelco submits also that there is an error of law in the Draft Access Order with tariffs being based on “forward looking costs”, as this concept is neither in the Access Regulation nor in section 57(e) governing default pricing for access services.

### **TRA analysis and conclusion**

81. Referring to Zain’s comments on LLU prices, TRA agrees that LLU prices should not deter investment in efficient alternative infrastructure. TRA believes that this is achievable through benchmarking. For example, the New Zealand Commerce Commission, which is required by Law to set wholesale rates through benchmarking initially, explicitly took this type of consideration when it set LLU rates in November 2007<sup>3</sup>. Further when setting LLU rates in the European Union, regulators have had to set prices that do not deter investment in alternative infrastructure: *“The imposition by national regulatory authorities of mandated access that increases competition in the short-term should not reduce incentives for competitors to invest in alternative facilities that will secure more competition in the long-term”*<sup>4</sup>. However, TRA’s objective is not protect investment as such. Rather TRA aims to provide the right incentives for efficient investment in alternative infrastructure, regardless of the technology deployed. If the copper local loop infrastructure proves to be more efficient than other competing infrastructure in the long term, then it would be contrary to TRA’s objectives to protect these competing infrastructures. This is also why TRA believes it is important to rely on Batelco’s costing information to complement benchmarked values to set LLU prices for the first Reference Offer since it will reflect the costing features of Batelco’s local loop.

82. With respect to Batelco’s comments on LLU prices, TRA disagrees with Batelco’s arguments that benchmarking is likely to be problematic:

- With respect to (a) above, benchmark values are sometimes used by regulators, especially in small countries. This is the case, for example, in New Zealand for LLU prices<sup>5</sup>. TRA reminds that it proposes to complement benchmarked prices with Batelco’s costing information;
- With respect to (b) above, TRA believes that it is important not to delay the implementation of LLU. TRA is of the view that the combination of the analysis of Batelco’s cost information currently available and of benchmarking with potential adjustments reflecting local specificities is sufficient to ensure that prices are set appropriately for the first LLU prices ;
- With respect to (d) and (f) above, TRA will take into account of exchange rate fluctuations and of local circumstances when using the benchmark approach to the extent that they affect cost.

---

<sup>3</sup> See Commerce Commission, Standard Terms Determination for the designated service Telecom’s unbundled copper local loop network, Decision 609, 7 November 2007.

<sup>4</sup> Directive 2002/19/EC of the European Parliament and of the Council, 7 March 2002, on access to, and interconnection of, electronic communications networks and associated facilities (“Access Directive”)

<sup>5</sup> See Commerce Commission, Standard Terms Determination for the designated service Telecom’s unbundled copper local loop network, Decision 609, 7 November 2007, for an account of how LLU rates were set in New Zealand based on a sophisticated benchmarking approach, including via regression analysis

- With respect to (c) above, TRA will consider the impact of LLU prices on other wholesale markets when setting LLU prices. However, TRA reminds that because LLU is at the top of the investment ladder, LLU price is an input for other wholesale products;
  - With respect to (e) above, TRA believes that tariff rebalancing is a retail issue and does not generate any issue at the wholesale level to the extent that wholesale prices are cost-oriented. To the extent that tariff rebalancing may give rise to specific issues, there are no reasons to believe that they cannot be accommodated, if relevant and appropriate;
  - With respect to (g) above, TRA believes that it is preferable to use benchmarked prices in countries where LLU has been in place for several years as it means that LLU prices are more robust in these countries.
83. As a conclusion, having considered the views of respondents, TRA remains of the view the first LLU prices should be set having regard to the analysis of Batelco's cost information currently available and benchmarking.
84. TRA agrees that the reference about "forward looking" costs should be removed in the Order. In accordance with Article 57(e) of the Law, the Authority may determine tariffs as it considers appropriate if it considers that such tariffs are unreasonable: in that case, provisions of Article 57(b) shall apply, which provides for tariffs being based on forward-looking incremental costs or by benchmarking such tariffs against tariffs in comparable telecommunications markets.

#### **Question 5.2**

Do you agree with TRA's proposition that "price on application" should be avoided in Batelco's LLU RO? Do you also agree with TRA's proposition to avoid possible upfront fees and to transform possible upfront fees into recurring charges?

#### **The March 2009 Consultation Document**

85. TRA believed that "price on application" should be avoided wherever possible, thereby providing greater certainty and transparency to OLOs. TRA also believed that ancillary service upfront fees should, as far as possible, be annualised and transformed into recurring fees.

#### **Responses to the March 2009 Consultation Document**

86. Kalaam Telecom, and Lightspeed agree with TRA's view.
87. Batelco disagrees with TRA's proposition. Batelco believes that removal of price on application causes Batelco to be unable to recover capital costs on any significant investment made by Batelco for LLU (for example, developing billing systems). Batelco therefore submits that it is only fair to impose a "price on application".

#### **TRA analysis and conclusion**

88. Having considered the views of respondents, TRA remains of the view that "price on application" should be avoided wherever possible and this is not in contradiction with Batelco's recovering capital costs on any significant investment by Batelco for LLU.

TRA remains also of the view that ancillary service upfront fees should be, as far as possible, annualised and transformed into recurring fees.

## **5 Anticipating the main operational issues that could occur during the initial LLU implementation phase**

### **Question 6.1**

Do you agree with TRA's non-discrimination approach that should guide the definition of operational processes and the drafting of the LLU offer?

Do you agree with TRA's proposition to request from Batelco a description of its relevant internal processes for the purpose of the Approval of the LLU Reference Offer?

### **The March 2009 Consultation Document**

89. TRA was of the view that the definition of operational processes and the drafting of the LLU Reference Offer should rely as much as possible on Batelco's own processes and practices. TRA therefore proposed requiring from Batelco a list and description of internal processes pertaining to the provisioning of lines, together with any associated commitments towards its own end-users.

### **Responses to the March 2009 Consultation Document**

90. All OLOs (Kalaam Telecom, and Lightspeed) agree with TRA's view.
91. Lightspeed underlines that TRA's proposition will ensure that Batelco does not favour its own retail arm. Lightspeed alleges that Batelco has engaged in such anti-competitive behaviour in the past.
92. Lightspeed adds that TRA should ensure that Batelco provides continuous and up-to-date updates of its internal processes to all licensed operators in the market.
93. Batelco does not agree with TRA's approach. According to Batelco, TRA's approach amounts to an unofficial policy of implementing functional separation and/or "equivalence of inputs" without parameters, without consultation and without basis under the Telecommunications Law. Batelco submits that the issue of functional separation and/or equivalence should be fully addressed through further public consultation. Batelco is of the view that there can be justified differences between wholesale and retail processes and that it can be very costly to have exactly the same wholesale and retail processes.
94. Batelco estimates, furthermore, that internal processes are confidential and are constantly updated and subject to change. As a consequence, Batelco disagrees with TRA's proposition to provide internal processes.

### **TRA analysis and conclusion**

95. Regarding Lightspeed's comments, TRA rejects the suggestion that Batelco should provide OLOs its internal processes, since it considers that it is TRA's responsibility to check that the non-discrimination principle is applied and TRA will investigate complaint from OLOs.

96. Regarding Batelco's comments, TRA wishes to clarify that the March 2009 Consultation Document does not propose implementing a functional separation or equivalence of inputs. Rather, TRA considers that it is essential that LLU processes are guided "as much as possible" by internal retail processes. TRA understands indeed that there can be cases where it is not possible to have similar processes between retail and wholesale activities. However, TRA is of the view that these cases are rare. As a consequence, TRA considers that the principle of non-discrimination should guide the definition of LLU processes and, in a case where processes cannot be similar, Batelco will have to justify it.
97. The principle of non-discrimination is fully recognized in the Telecommunications Law and the Access Regulation. Article 57 of the Telecommunications Law e) which sets out the rules and principles in relation to the provision of Access to be offered by a Dominant Operator provides that if the terms and conditions on which Access is offered are not reasonable, TRA is entitled to determine such terms and conditions as it considers appropriate. This paragraph further refers to paragraph b) of Article 57 of the Telecommunications Law in connection with the principles to be respected by the TRA while determining such terms and conditions. One of the principles recognized in the relevant paragraph is the principle of non-discrimination.
98. TRA reminds furthermore that non-discrimination is a key regulatory principle in other jurisdictions, such as in Europe, where it is used as a basis for determining LLU processes without functional separation or equivalence inputs being necessarily implemented. The approach of TRA in connection with LLU is not related with the implementation of functional separation. The principle of non-discrimination aims at ensuring that Batelco does not favour its own retail arm while granting access to its local loop. This approach is also in line with the Position Paper No. 2 of 2007 issued by TRA on price and non-price discrimination.
99. As a consequence, having considered the views of respondents, TRA remains of the view that the definition of operational processes and the drafting of LLU offer should be guided as much as possible by Batelco's own processes and practices. TRA therefore will require from Batelco a list and description of internal processes pertaining to the provisioning of lines, together with any associated commitments towards its own end-users.

#### **Question 6.2**

Do you agree with TRA's approach to the provision of specific information related to LLU within the LLU RO of Batelco? Which items of the list above are relevant in the specific context of LLU implementation in Bahrain and should be included in the LLU RO? What are the objective criteria to be used for assessing whether an item of the list above should be considered commercially sensitive in the specific context of LLU implementation in Bahrain?

#### **The March 2009 Consultation Document**

100. TRA acknowledged that the following information could be useful for OLOs in the context of LLU implementation:

- The number of non-active and active lines suitable for LLU;
- The geographical location of the Service Nodes (national address);
- The average length of copper local loops (meters);
- Power availability at each of Batelco's Service Nodes;
- Service Node space availability;
- Cable entry points (first manhole closest to the exchange) and duct capacity available;
- General information on cable characteristics;
- Results of any xDSL tests.

### **Responses to the March 2009 Consultation Document**

101. Kalaam Telecom, and Lightspeed) agree with TRA's approach.
102. Batelco agrees to a certain point. As a matter of fact, Batelco considers that some of the information specified in the list above is commercially sensitive and not relevant to LLU implementation and should therefore not be included in the LLU Reference Offer. Examples are: cable entry point for security reasons and the number of non-active lines.
103. Batelco explains also that the provision of this information is time-consuming and administratively difficult to extract, especially because it is quickly out-of-date. Batelco proposes that the information be provided on a case-by-case basis.
104. Batelco underlines, furthermore, that, thanks to the information provided, OLOs will be able to discriminate between sites, resulting in a two tier telecommunications system, where those sites not deemed worthy of OLO investment may be left out.
105. Batelco adds that, if only the distant collocation offer was allowed, it would not be necessary to provide information about power and space availabilities.

### **TRA analysis and conclusion**

106. TRA disagrees with Batelco on the fact that cable entry point and the number of non-active lines should not be provided to OLOs because they are commercially sensitive and not relevant to LLU implementation. Firstly, TRA reminds that OLOs will have to sign a confidentiality agreement. Secondly, this information is mainly technical and is not commercially sensitive as such. TRA observes that Batelco has not justified why the information could be commercially sensitive. Thirdly, this information is relevant to LLU implementation: the cable entry point location is useful for OLOs wishing to deploy their own backhaul (TRA observes that the information about cable entry point location is provided by incumbents in several other jurisdictions) and the number of non-active lines gives an indication to OLOs about the possible level of economies of scale that can be achieved with LLU.
107. TRA acknowledges that the provision of this information can be difficult. However, TRA believes that Batelco must collect this information for its own purposes. TRA also believes that Batelco should be allowed to recover the efficient costs associated with the provision of such up-to-date information. TRA is of the view that it is fair to request Batelco to update this information only on a quarterly basis and to provide it to OLOs on request.
108. As a consequence, having considered the views of respondents, TRA remains of the view that the information detailed in the Order should be provided, if available.

**Question 6.3**

Do you agree with TRA's view that both a cost-oriented LLU backhaul offer from the incumbent and enabling backhaul built by OLOs are necessary? If yes, could you please detail your expectations for the LLU backhaul offer to be provided by Batelco (bandwidth of backhaul, type of protocol, etc.)?

Could you also please detail your expectations in terms of self-providing LLU backhaul (e.g. deployment of fibre into Batelco's Service Node) or purchasing LLU backhaul from another OLO?

**The March 2009 Consultation Document**

109. TRA was of the view that both a cost-oriented LLU backhaul offer from the incumbent and enabling backhaul built by OLOs are necessary. TRA requested the industry to provide its expectations for LLU backhaul.

**Responses to the March 2009 Consultation Document**

110. All respondents agree with TRA's proposition.

111. Kalaam Telecom specifies that fibre-based backhaul is the appropriate option.

112. Lightspeed specifies that dark fibre, duct access, Gigabit Ethernet but also microwave links or using third-party infrastructure should be possible.

113. Batelco expresses that it is happy to offer backhaul on reasonable request subject to technical feasibility to the extent that the backhaul price is above costs plus a mark-up.

**TRA analysis and conclusion**

114. Having considered the views of respondents, TRA remains of the view that both a cost-oriented LLU backhaul offer from the incumbent and enabling backhaul built by OLOs are necessary. Any type of backhaul built by OLOs should also be allowed.

#### **Question 6.4**

Do you agree with TRA's proposed rule for space allocation?

Do you agree with TRA's proposed specific process for space allocation for the very first collocation ordering?

Is there any justification for such a coordinated approach to be envisaged after the very first collocation ordering for subsequent orderings? Please elaborate.

#### **The March 2009 Consultation Document**

115. Based on a review of international best practices, TRA was of the view that the following five rules should be adopted in order to ensure an efficient allocation of space between requesting OLOs:

- "First Come, First Served";
- "Use it or Lose it";
- One single space allocated per OLO per Service Node;
- Batelco should rely on effective demand for site preparation, and as a general rule it should not be required of Batelco to provide space in advance for all or part of its Service Node sites;
- If several collocation options are available, the cheapest option should always be proposed by Batelco.

116. TRA also proposed a specific process for the very first collocation ordering.

#### **Responses to the March 2009 Consultation Document**

117. Kalaam Telecom, and Lightspeed agree with TRA's proposed rules for space allocation and with the first collocation ordering proposition.

118. Kalaam Telecom believes that the specific process for the very first collocation ordering is not complex and should be used for subsequent collocation orders.

119. Lightspeed wishes that TRA always controls Batelco's space allocation and Batelco's space availability and that TRA ensures Batelco is acting in a fair and transparent manner.

120. Lightspeed suggests that OLOs send two collocation orders: one to Batelco and one to TRA, in order for TRA to monitor Batelco's provisioning obligations.

121. Lightspeed suggests that Batelco should always provide alternative solutions in case of rejection of a collocation order.

122. Regarding general collocation rules, Batelco submits first that distant collocation avoids these issues. Batelco explains in addition that it reserves its position to propose another allocation method if there are cases of high demand in limited spaces. Batelco suggests a simplified lottery ballot for congested Service Nodes.

123. Regarding the proposed rules for the first collocation ordering, Batelco believes that removing space allocation rules would provide OLOs with fair and reasonable treatment. Batelco adds that the allocation process should not only apply to the first collocation order because LLU may be more successful later than at initial launch and that the fastest operator may not be the best operator.

### **TRA analysis and conclusion**

124. Regarding Kalaam Telecom's comments, TRA agrees with the fact that the specific process described for the very first collocation orders process is not complex. However, TRA is of the view that such a process slows down the development of LLU and does not give sufficient room for manoeuvre to OLOs in their investment timing strategy in LLU. The moment for ordering a collocation space in a given MDF would indeed be imposed to OLOs with such a process. TRA is also of the view that such a process could result in situations where Batelco always rejects collocation orders because the number of orders are too high, resulting in the fastest OLOs not being able to collocate at Batelco's exchanges.
125. Referring to Lightspeed's comments, TRA has no objections to its suggestions that OLOs could send one collocation order to Batelco copying TRA. It will indeed enable TRA to have a view on the space allocation process, if needed.
126. However, TRA disagrees with Lightspeed's suggestion that TRA should always control the allocation of space and the space availability. TRA believes that the conditions of the Reference Offer and the rules proposed here will ensure that the allocation of space is fair and reasonable. However, if OLOs do not consider Batelco is acting in a fair and reasonable manner, OLOs can lodge a formal complaint to TRA for investigation.
127. TRA disagrees with Lightspeed's suggestion that Batelco should always propose alternative options, since TRA is of the view that if an MDF is fully congested and no space is available on Batelco's property, it is not Batelco's duty to find a collocation option.
128. Regarding Batelco's comments on proposed rules for the first collocation ordering, TRA agrees that the fastest operator may not be the best operator. However, TRA considers that no allocation process enables the selection of the best operator. The "First Come, First Served" rule has therefore the advantage of not slowing down the development of LLU. As a consequence, TRA believes that the specific process for very first collocation ordering should not be extended to subsequent orderings and that the "First Come, First Served" rule should be preferred for the first ordering only.
129. Regarding Batelco's comments on proposed general rules, TRA notes that Batelco reserves its position to propose another allocation method if there are cases of high demand in limited spaces. TRA reminds that the goal of this consultation process is to find the best option for space allocation. In absence of Batelco's comments, TRA remains of the view that the five rules it has proposed should be adopted. In particular, TRA believes that the simplified lottery ballot proposed by Batelco for congested MDF is not better than other rules for space allocation and slows down LLU development compared to the preferred "First Come, First Served" rule.
130. TRA also notes that some comments about collocation solutions have been made by Batelco. TRA agrees with Batelco about the fact that distant collocation avoids space allocation issues. However, TRA does not believe it is a sufficient reason for rejecting other collocation options. TRA indeed believes, based on the international experience

with LLU, that distant collocation should not be considered the preferred option for LLU development.

131. Having considered the views of respondents, TRA remains of the view that the five general rules it has proposed in the March 2009 Consultation Document should be used for space allocation, as well as the specific process for space allocation for the very first collocation orders, if the number of OLOs applying for the service within the 14 days from the launch of LLU are more than 3. TRA believes that this latter process is not appropriate for subsequent collocation orders.

#### **Question 6.5**

What are your views on how to implement the “Use it or Lose it” rule? Please explain in detail.

#### **The March 2009 Consultation Document**

132. TRA was of the view that a specific rule should be applied to allocate space between OLOs. One of the rules is the “Use it or Lose it” rule. With this rule, if an OLO has been granted space but has not used this space after the specified reasonable period of time, the space will be released and re-allocated. The goal of this rule is to prevent the inefficiencies created by hoarding space.
133. TRA considered that there were several options to implement the “Use it or Lose it” rule. For example, this rule could include examples such as the OLO’s exchange equipment not being installed or being installed but not connected to the OLO’s core network within 3 months of space allocation, in which case it would have to be removed at the OLO’s cost (except if the delay is caused by third-party issues such as delays in the provision of backhaul services by Batelco). As a consequence, TRA requested the industry’s view on the implementation of this rule.

#### **Responses to the March 2009 Consultation Document**

134. Kalaam Telecom, Zain and Lightspeed agree with TRA’s view.
135. Kalaam Telecom believes that such a rule should be implemented and that the proposed 3-month period should be sufficient.
136. Zain believes that TRA should specify more precisely the meaning of “Use” in the “Use it or Lose it” rule. Zain proposes that each OLO with less than 50 LLU customers 3 months after the space being allocated should lose the space.
137. Lightspeed believes that the “Use it or Lose it” rule should be implemented to the extent that the reasons for not using the space within 3 months are not due to the incumbent’s anti-competitive behaviour.
138. Batelco submits that TRA should consider other criteria for the “Use it or Lose it” rule such as fulfilling the supply terms of the Reference Offer. Batelco adds that, provided that payment obligations apply from a certain date, the OLO can reserve that space.

## TRA analysis and conclusion

139. Regarding Zain's proposition that if less than 50 customers are connected to an OLO's equipment 3 months after the space being allocated to this OLO the OLO should lose that space, TRA is of the view that the proposed number of customers is high, especially because for small MDFs and in the early stages of LLU implementation, it may take time for an OLO to get 50 customers. TRA is also of the view that once the space is allocated by Batelco to an OLO, the OLO has to pay collocation charges to Batelco, which also prevents the OLO from inefficiently pre-empting the allocated space. It is therefore not necessary to specify more stringent conditions on OLOs for the use of allocated space.
140. TRA agrees with Lightspeed's comments and further believes the "Use it or Lose it" rule should not apply if:
- Batelco does not respect the SLAs related to ancillary services delivery or LLU line delivery or more generally Batelco engages in anti-competitive behaviour related to LLU;
  - The OLO proves that the delay has been caused by third parties (equipment vendors, municipalities in the case of OLOs laying their own fibre backhaul).
141. Finally, with respect to Batelco's comments, TRA considers that the fulfilment of the Supply Terms of the Reference Offer by the OLOs is a point that will be more generally dealt with in the Reference Offer and is not directly linked with the "Use it or Lose it" rule.
142. Having considered the respondents views, TRA is of the view that an appropriate approach for implementing the "Use it or Lose it" rule is to consider that an OLO will lose its allocated space if no customer is connected to the OLO's equipment through LLU 3 months after the space being allocated to the OLO by Batelco. TRA also considers that the 3-month period may need to be reviewed in the course of LLU implementation since it also depends on the delivery time of ancillary services on which Batelco will commit.

### Question 6.6

Do you agree with TRA's proposition to allow end-users to sign a document authorising an OLO to perform all the necessary actions with the incumbent for having their line unbundled, including fixed number portability when appropriate?

Do you agree with TRA's proposition that the consequences of terminating the contract with Batelco should not be a barrier to change from Batelco to an OLO?

## The March 2009 Consultation Document

143. TRA's proposition was to allow end-users to sign a document authorising an OLO to perform all the necessary actions with the incumbent for having their line unbundled, including fixed number portability, so that the relationship between end-users and the incumbent ceases.

144. TRA was also of the view that the consequences of terminating the contract with Batelco should not be a barrier to change from Batelco to an OLO.

### **Responses to the March 2009 Consultation Document**

145. All respondents agree with TRA's view.

146. However, Zain and Batelco both specify that end-users should pay all outstanding debts before the move to LLU.

147. Zain adds that fixed number portability should be in a different document.

### **TRA analysis and conclusion**

148. Regarding TRA's proposition to allow end-users to sign a document authorising an OLO to perform all the necessary actions with the incumbent for having their line unbundled, TRA observes that all respondents agree with it and remains therefore of the view that this proposition should apply.

149. TRA believes, furthermore, that it is appropriate to include fixed number portability in this document. If it was in a separate document, it would complicate, from the end-users' point of the view, the administrative steps for having their number ported and line unbundled at the same time. Nevertheless, to cater for the possibility for end-users to port their fixed number to another platform such as NFWS or fibre, a stand-alone document for fixed number portability will be available.

150. Regarding TRA's proposition that the consequences of terminating the contract with Batelco should not be a barrier to change from Batelco to an OLO, TRA disagrees with Zain's and Batelco's suggestions that end-users should pay outstanding debts before moving to LLU because TRA notes that Batelco will keep its rights against the end-user in connection with the collection of the outstanding debts by way of legal means available under Bahraini Laws.

### **Question 6.7**

Do you agree with TRA's suggestion to request Batelco to release the ANFP for the field tests to occur in mid-2009 in Bahrain?

### **The March 2009 Consultation Document**

151. TRA's suggestion was that Batelco should release the ANFP for the field tests (which would occur in mid-2009).

### **Responses to the March 2009 Consultation Document**

152. All respondents agree with TRA's view on making an ANFP available.

153. However, Batelco believes that the timeframe proposed by TRA to release such an ANFP is too short, since Batelco will need to issue an RFP to obtain a suitable document.

## TRA analysis and conclusion

154. Regarding Batelco's comments on the proposed timeframe for releasing an ANFP, TRA observes that a request was sent by TRA to Batelco in January 2009 to collect information that could be used to prepare an ANFP<sup>6</sup> for Local Loop Unbundling (LLU). Batelco answered in March 2009. In April 2009, TRA requested some clarifications about Batelco's answer. Batelco answered in mid-May 2009. Therefore, TRA observes that this information, requested 8 months ago by TRA from Batelco, constitutes the bulk of an ANFP and significantly enables anticipation of its drafting. TRA believes therefore that, thanks to the answers provided to TRA by Batelco, Batelco is in a position to release an initial ANFP suitable for field tests.
155. TRA is also of the view that the ANFP is a living document that will have to be updated over the coming years.
156. As a consequence, having considered the views of respondents, TRA remains of the view that Batelco should release an initial ANFP at the time field tests begin, using the information exchanged with TRA so far.

### Question 6.8

Do you agree with TRA's proposition not to implement bulk migration in LLU implementation?

## The March 2009 Consultation Document

157. TRA's view was that it is not necessary to implement a bulk migration process for the implementation of LLU.

## Responses to the March 2009 Consultation Document

158. Kalaam Telecom, and Batelco agree with TRA's view.
159. Lightspeed has misinterpreted the meaning of "bulk migration".
160. Batelco underlines that TRA's requests to withdraw Bitstream and WDSL in Bahrain implies that customers will have to be migrated in bulk for LLU. Batelco also adds that TRA has not defined "bulk".

## TRA analysis and conclusion

161. Having considered the views of respondents, TRA remains of the view that "bulk migration" should not be implemented.
162. As the word "bulk" seems to have been misinterpreted, TRA defines here "bulk migration" as the process corresponding to multiple migrations of WDSL or bitstream users to LLU with no change to the contract with end-users. TRA refers *inter alia* to the

---

<sup>6</sup> Also called Interference Management Plan (IMP)

### **Question 6.9**

Do you agree with TRA's proposition for the forecasts to be done by OLOs?

Do you agree with TRA's proposition that OLOs should not pay any penalty if their orders for LLU services are different from forecasts? Do you agree with TRA's proposition that provisions are required to take into account forecasting tolerances? Please elaborate.

### **The March 2009 Consultation Document**

163. TRA stated that OLOs may be required to provide some forecasts to Batelco about their LLU plans in order to help the incumbent anticipate and plan associated activities. However, TRA was of the view that forecasts should not unduly constrain OLOs: if real orders from OLOs are slightly different from forecasts, OLOs should not be subject to penalty. TRA also considered that provisions were required to take into account forecasting tolerances.
164. TRA was also of the view that OLOs should provide forecasts about their future orders for LLU services:
- At most for the next 12 months and at least for the next 6 months for orders relating to collocation (including type and capacity of backhaul requested) and tie cables;
  - At most for the next 6 months and at least for the next 3 months for Full LLU orders.

### **Responses to the March 2009 Consultation Document**

165. All respondents agree with TRA's proposition to provide forecasts.
166. Kalaam Telecom agrees with TRA on the facts that:
- OLOs should provide forecasts,
  - OLOs should not pay any penalty if their orders for LLU services are different from forecasts,
  - Provisions are required to take into account forecasting tolerances.
167. Zain believes that forecasts should be done together by Batelco and OLOs. Zain also agrees with TRA on the facts that no penalty should be imposed on OLOs if their forecasts are different from their orders.
168. Lightspeed agrees to provide its forecasts to Batelco but rejects that such forecasts could be used as a commitment and that penalties could be paid if OLOs do not meet their forecasts. On the contrary, Lightspeed believes that the incumbent should pay penalties when the incumbent engages in anti-competitive behaviour.

---

<sup>7</sup>[http://www.openreach.co.uk/orgp/products/llu/mpfsmpf/downloads/Bulk%20Migrations%20Code%20of%20Practice%20Issue\\_1.0\\_.pdf](http://www.openreach.co.uk/orgp/products/llu/mpfsmpf/downloads/Bulk%20Migrations%20Code%20of%20Practice%20Issue_1.0_.pdf)

169. Batelco agrees with TRA's proposition that forecasts should be done by OLOs. However, Batelco proposes that OLOs should pay penalties in cases where Batelco invests in preparing sites following an OLO's order and the OLO then cancels its order.
170. Batelco agrees that OLOs should provide forecasts about their future orders for LLU services for the next 3 or 6 months. However, Batelco believes that 12 months or more is more appropriate for collocation and tie cables, rather than 6 or 12 months, because it needs to be aware of what requires to be prepared for LLU sites.

### **TRA analysis and conclusion**

171. Regarding Batelco's comments on the fact that OLOs should pay penalties when orders are different from forecasts, TRA believes that forecasts enable Batelco to anticipate the work that will need to be done but they do not generate the need for any investment by the incumbent. Only actual orders generate the need for investment by the incumbent. TRA agrees with Batelco that it may be appropriate for OLOs to face penalties in cases where Batelco invests in preparing sites following an OLO's order and the OLO then cancels its order. But TRA considers that OLOs should not pay any penalty in cases where Batelco invests in preparing sites following an OLO's forecast, prior to any order by OLOs.
172. With respect to Batelco's comments on values for forecast periods (Batelco is the sole respondent having provided comments on this), TRA has considered these comments and is of the view that OLOs should provide forecasts about their future orders for LLU services as follows:
- for the next 12 months for orders relating to collocation (including type and capacity of backhaul requested) and tie cables (Batelco proposes 12 months or more),
  - for the next 3 months for Full LLU orders (Batelco proposes 3 to 6 months).
173. Having considered the views of respondents, TRA remains of the view that forecasts should be given by OLOs to Batelco for the next 12 months for orders relating to collocation and for the next 3 months for Full LLU orders. TRA also believes that OLOs should not pay any penalties when orders differ from forecasts.

#### **Question 6.10**

Do you agree with TRA's list of a minimal set of parameters for SLAs that should be associated with LLU?

### **The March 2009 Consultation Document**

174. In the Consultation Document, TRA considered that, in light of the implementation difficulties encountered in Europe, the following minimum parameters should be set for SLAs:
- For Full LLU: line delivery, validation time (time required for the incumbent to consider an order as received and suitable) and delivery time;
  - For ancillary services: validation time (time required for the incumbent to consider an order as received and suitable) and delivery time;

- For fault clearance: validation time (time required for the incumbent to consider the fault forwarded by the OLO as received and acceptable) and repair time.

### **Responses to the March 2009 Consultation Document**

175. Kalaam Telecom, Zain and Lightspeed) agree with the list proposed by TRA.
176. Lightspeed proposes that there should also be SLAs associated with power for collocated equipment, air-conditioning, safety equipment and safety access.
177. Batelco believes that there should be SLAs only for LLU line delivery and fault clearance. Batelco adds that no SLA should be associated with ancillary services because their provision varies from case-to-case.
178. Batelco finally underlines that SLAs should be developed after the final processes are implemented and that it is an inefficient use of time to develop them beforehand.

### **TRA analysis and conclusion**

179. TRA rejects Batelco's view that there should not be any SLA for ancillary services. Firstly, TRA observes that the current practice abroad is generally to have SLAs for each ancillary service. Secondly, TRA believes that ancillary service provision is, in general, fairly standard (provision of space, provision of backhaul, provision of tie cables, etc.) except in some specific cases. This does not prevent Batelco from setting SLAs for ancillary services for non-specific cases. TRA acknowledges that Batelco will have to define what these specific cases are.
180. Regarding Batelco's additional comments stating that SLAs should only be developed after the final processes are implemented, TRA agrees with Batelco but believes that this does not prevent TRA either determining the appropriate list of SLAs or asking the industry for its views on the appropriate level of SLAs. As a consequence, TRA proposes that Batelco shall publish within its RO target SLAs and associated penalties. TRA will review the value for these parameters of SLAs on the basis of the LLU process assessment that will be reviewed with Batelco and on the basis of the opinion of respondents of the Consultation Document. Furthermore, Batelco shall publish on a monthly basis corresponding KPIs, based on which final SLAs will be defined, taking into account, whenever appropriate, benchmark information. Final SLAs will be set within 6 months from the date of LLU being commercially launched.
181. Having considered the views of respondents, TRA remains of the view that at a minimum the following parameters should be set for SLAs:
- For Full LLU line delivery, validation time and delivery time;
  - For ancillary service, validation time and delivery time;
  - For fault clearance, validation time and repair time.

For the purpose of this paragraph "validation time" refers to the time taken by Batelco between receiving the order or fault notification and the point of final assessment of the validity of that order or fault notification.

### Question 6.11

Please specify and justify the value for the following parameters of SLAs:

Validation time for:

- Full LLU line provisioning
- Information provisioning
- Internal tie cable provisioning
- External tie cable provisioning
- Dedicated collocation space provisioning
- Co-mingling space provisioning
- Shelter space provisioning
- Backhaul provisioning by incumbent

Delivery time for:

- Full LLU line provisioning
- Information provisioning
- Internal tie cable provisioning
- External tie cable provisioning
- Dedicated collocation space provisioning
- Co-mingling space provisioning
- Shelter space provisioning
- Backhaul provisioning by incumbent

Problem resolution time for:

- Fault clearance
- Backhaul repair
- Access to Service Nodes

### The March 2009 Consultation Document

182. TRA asked the industry for its views on the appropriate parameters of SLAs.

### Responses to the March 2009 Consultation Document

183. The industry answers are summarised in the table below:

	Kalaam Telecom	Lightspeed	Batelco
<b>VALIDATION TIME</b>			
Full LLU line provisioning	3 weeks	2 c weeks	3 days
Information provisioning	2 weeks	10 c days	7 days
Internal tie cable provisioning	2 weeks	15 c days	7 days
External tie cable provisioning	3 weeks	15 c days	7 days
Dedicated collocation space provisioning	2 weeks	1 c week	7 days

Co-mingling space provisioning	2 weeks	1 c week	7 days
Shelter space provisioning	3 weeks	1 c week	7 days
Backhaul provisioning by incumbent	2 weeks	5 days	7 days
<b>DELIVERY TIME</b>			
Full LLU line provisioning	6 weeks	10 w days	8 days
Information provisioning	2 weeks	10 w days	Case by case
Internal tie cable provisioning	4 weeks	20 w days	Case by case
External tie cable provisioning	6 weeks	20 w days	Case by case
Dedicated collocation space provisioning	4 weeks	30 w days	Case by case
Co-mingling space provisioning	2 weeks	30 w days	Case by case
Shelter space provisioning	6 weeks	30 w days	Case by case
Backhaul provisioning by incumbent	4 weeks	30 w days	Case by case
<b>PROBLEM RESOLUTION TIME FOR</b>			
Fault clearance	24 hours	90% in 72 cl hours and 99% in 144 cl hours	24 hours
Backhaul repair	4 hours	8-12 cl hours	4 hours
<b>ACCESS TO SERVICE NODES</b>			
Access	1 hour (pre-authorized)	1 cl hour	4 hours

*NB: "w" means "working"; "c" means calendar; "cl" means clock.*

184. Batelco adds that the LLU delivery process actually involves two activities: current service cessation plus LLU provision, which implies that the LLU SLA is 2 days longer than the retail KPI.

#### **TRA analysis and conclusion**

185. TRA thanks the industry for these inputs. TRA will consider taking them into account when assessing SLAs and processes in the LLU Reference Offer Service Description.

186. TRA notes the point raised by Batelco on possible differences in processes and will take this into account in assessing SLAs as appropriate.

**Question 6.12**

Comments are requested with respect to the proposed establishment of SLAs.

**The March 2009 Consultation Document**

187. TRA requested comments on these proposed SLAs.

**Responses to the March 2009 Consultation Document**

188. Kalaam Telecom submits that Batelco should publish corresponding KPIs. Benchmark information should be considered as well for the setting of SLAs. Kalaam Telecom also suggests that final SLAs should be set 6 months after LLU implementation.

189. Lightspeed underlines the importance of SLAs with associated penalties and states that if OLOs need a better level of quality of service, Batelco should provide such levels of quality of service at a reasonable cost.

**TRA analysis and conclusion**

190. TRA thanks the industry for these comments.

191. TRA agrees with Kalaam Telecom that benchmark information should be considered when setting SLAs.

192. TRA agrees with Lightspeed that if an OLO requests a better level of quality of service, Batelco should provide it. However, TRA considers that, in application of the non-discrimination principle, Batelco may be entitled either to refuse to provide a better level of quality of service for LLU if this level is better than the level provided at Batelco's retail arm or to accept to provide it at a reasonable price.

**6 Monitoring the development of LLU****Question 7.1**

What is the minimal set of KPIs for LLU that should be measured on a monthly basis and published by Batelco on its website? Do you agree with TRA's intention to request Batelco to measure and publish the corresponding minimum set of KPIs for other wholesale and retail products necessary to assess *prima facie* compliance with non-discrimination?

**The March 2009 Consultation Document**

193. TRA was of the view that Batelco should be obliged to periodically report Key Performance Indicators (KPIs) to TRA (as part of the regulatory requirements relating to the Quality of Service) and where appropriate to OLOs.

194. TRA was of the view that the minimum set of KPIs that should be measured on a monthly basis and published by Batelco on its website for LLU was the following:
- i. Average delivery time (in days)
    - For active lines
    - For non-active lines
    - For all (active and non-active lines)
  - ii. % of delivery before or on the committed date
    - For active lines
    - For non-active lines
    - For all (active and non-active lines)
  - iii. % of faults cleared in less than 'x' hours
    - For all (active and non-active lines)

### Responses to the March 2009 Consultation Document

195. All respondents agree with TRA's proposal of KPIs.
196. Zain suggests that Batelco should send to each OLO the KPIs related to each MDF area for the MDFs that it unbundles. Zain also proposes to have some penalties imposed on Batelco, payable to the OLOs, if it does not match these sets of KPIs.
197. Lightspeed proposes the following list of KPIs:

KPI	Target
Volume of orders completed - Aggregate	
% of pre-order enquiries accepted, completed within target - Shared MPF	98%
% of pre-order enquiries accepted, completed within target - MPF	98%
% of pre-order enquiries non-fatally rejected - Shared MPF	
% of pre-order enquiries non-fatally rejected - MPF	
% of pre-order enquiries fatally rejected - Shared MPF	15%
% of pre-order enquiries fatally rejected - MPF	15%
Average lapse time from order receipt to Customer Agreed Date - Shared MPF	
Average lapse time from order receipt to Customer Agreed Date - MPF	
% of line characteristics provided within two days	
LLU Plan & Build Orders Success Rate - (4-week Rolling Average)	
The percentage of full survey issued to operators within 40 working days of an operator's request for such survey	85%
The percentage of works provided to operators and completed on or before Target Date.	85%
% of repeat faults (occurring within 30 days of the previous fault clearance)	
% of faults escalated to Level 2	
% of standard care faults repaired in 28 working hours	
% of total care faults repaired in 24 clock hours	
Early Life Failures - fault reported within 28 calendar days of installation - Shared MPF	3%
Early Life Failures - fault reported within 28 calendar days of installation - MPF	7.5%
Dead on Arrivals - fault reported within 4 calendar days of installation - Shared MPF	
Dead on Arrivals - fault reported within 4 calendar days of installation - MPF	
% of Shared MPF faults cleared - 40 clock hours	80%
% of MPF faults cleared - 40 clock hours	80%
% of Shared MPF faults cleared - Enhanced Care - 20 clock hours	
% of MPF faults cleared - Enhanced Care - 20 clock hours	80%

198. Batelco agrees with TRA that KPIs should be published for transparency purposes but considers that these KPIs should be based on the SLAs to avoid duplicate measurements and control. Batelco underlines that KPIs and SLAs cannot be developed until final processes are implemented.

## **TRA analysis and conclusion**

199. TRA observes that there is some confusion in the industry between KPIs and SLAs. TRA proposes therefore first to redefine these concepts.
200. KPIs (Key Performance Indicators) are the metrics that enable measurement of the performance of the incumbent's processes.
201. SLAs (Service Level Agreements) are the levels of quality of service to which the incumbent commits for delivering its services.
202. In other words, KPIs enable measurement of whether the incumbent achieves its SLAs. As a consequence, comments about SLAs and penalties are not the subject of this question (but rather of Questions 6.10, 6.11 and 6.12).
203. Regarding Zain's proposition to produce KPIs per MDF for each OLO, TRA rejects this as it would be very complex and costly for Batelco to provide such individual reports. TRA adds that it is not aware of such a practice being undertaken in other places around the world.
204. While Lightspeed list of proposed KPIs is useful, TRA is of the view that it cannot be used as such since:
- It incorporates KPIs related to Line Sharing,
  - It incorporates concepts such as "Customer Agreed Date", "Enhanced Care", "Early Life Failures", "Dead on Arrivals", etc. that will not necessarily be relevant in the context of the Kingdom of Bahrain,
  - Targets are related to SLAs and not KPIs.
205. Regarding Batelco's comments, TRA agrees with Batelco on the fact that KPIs and SLAs cannot be implemented until processes are in place. However, TRA is of the view that these will have to be in place once LLU is commercially launched. TRA considers that KPIs should be consistent with SLAs but emphasises that SLAs and KPIs are different concepts.
206. As a consequence, having considered the views of respondents, TRA remains of the view that the KPIs, set out in the Access Order, should be measured on a monthly basis and published by Batelco on its website.

### **Question 7.2**

Do you agree with TRA's proposition to publish an LLU scorecard that would include: (a) the number of unbundled lines; (b) the number of unbundled MDFs; and (c) the LLU coverage on the basis of a map once LLU is commercially launched? Do you see other indicators that should be included in this scorecard?

## **The March 2009 Consultation Document**

207. TRA proposed to publish an LLU scorecard that would include the number of unbundled lines, the number of unbundled MDFs and the LLU coverage.

## **Responses to the March 2009 Consultation Document**

208. All respondents agree overall with TRA's proposition on LLU scorecards.
209. Lightspeed proposes to add other indicators:
- Number of ordered unbundled lines compared to lines physically unbundled
  - Time period of unbundling the lines
  - Number of faults
210. Lightspeed also advises that an independent third party should be mandated to publish a report on TRA's performance related to LLU.
211. Batelco agrees with TRA's proposition overall but believes that the LLU coverage map is not necessary and its update would require significant effort.

## **TRA analysis and conclusion**

212. Regarding Lightspeed's comments, TRA observes that the additional indicators proposed by Lightspeed are KPIs, which are dealt with in Question 7.1 of the Consultation Document.
213. With respect to Batelco's comments, TRA believes that the production of an updated LLU coverage map is not a difficult exercise since the number of MDFs in Bahrain is limited.
214. Having considered the views of respondents, TRA remains of the view that an LLU scorecard that would include the number of unbundled lines, the number of unbundled MDFs and the LLU coverage should be published once LLU is commercially launched.
215. TRA is of the view that Lightspeed's advice to mandate a third party to publish a report on TRA's performance related to LLU is not relevant.

### **Question 7.3**

Do you agree with TRA's proposition to create a Working Group on LLU Operations and Service Schedules that will review the progress of LLU and suggest amendments to the LLU RO? Do you also agree with TRA's opinion that the evolution of and amendments to the ANFP should also be discussed within a Working Group on ANFP?

## **The March 2009 Consultation Document**

216. TRA proposed to create: a Working Group on LLU Operations and Service Schedules that will review the progress of LLU and suggest amendments to the LLU RO; and a Working Group on ANFP to discuss the evolution of and amendments to the ANFP.

## **Responses to the March 2009 Consultation Document**

217. Kalaam Telecom, and Lightspeed) agree with TRA's proposition.

218. Lightspeed advises that these Working Groups should be created immediately to start discussions between OLOs and Batelco on LLU.
219. Batelco disagrees with TRA's proposition. Batelco recognises the importance of inputs from OLOs. However, it explains that it does not see the value of multiple reviews of the LLU Reference Offer and that there is a need for a commercial balance that serves all parties. Batelco adds that issues are handled through an escalation process.

### **TRA analysis and conclusion**

220. With respect to Lightspeed's comments, TRA believes that it would not be useful to start these discussions before the first Reference Offer is published since these discussions are related to the Reference Offer and it envisages organising the first meeting a few months after the LLU Reference Offer is published.
221. With respect to Batelco's comments, TRA is of the view that the Reference Offer is a living document. TRA believes that the first version of the Reference Offer may require subsequent amendments. Based on international experience and also on local experience, TRA considers that Reference Offers and wholesale offer specifications often need to be adjusted over time to reflect the needs of OLOs.
222. Having considered the views of respondents, TRA remains of the view that it is necessary to create a Working Group on LLU Operations and Service Schedules that will review the progress of LLU and suggest amendments to the LLU RO Service Descriptions and to create a Working Group to discuss the evolution of and amendments that may be required to the ANFP.

## **7 Operational or Structural Separation of the Local Loop**

### **Question 8.1**

Do you agree with TRA's opinion that structural separation should not be considered at the current time but should be envisaged in the future if TRA determines the existence of anti-competitive practices by the incumbent such that LLU deployment is stymied?

### **The March 2009 Consultation Document**

223. TRA's view was that structural separation of the incumbent should not be considered at the current time but could be envisaged in the future if TRA determines the existence of anti-competitive practices by the incumbent such that LLU deployment is stymied.

### **Responses to the March 2009 Consultation Document**

224. Kalaam Telecom, and Lightspeed agree with TRA's proposition.
225. Batelco considers that this issue should not be included within this Consultation Document but should be consulted upon in another consultation. Batelco believes that this is an extreme regulatory remedy. Batelco notes also that only structural separation is discussed and not functional separation.

## **TRA analysis and conclusion**

226. TRA believes that where anti-competitive practices by the incumbent are found such that LLU deployment is obstructed, structural separation may be considered. Structural separation would ensure that the incumbent's processes, prices and quality of service are not discriminatory. It can therefore be a very powerful tool for LLU since the successful implementation of LLU mainly depends on the absence of anti-competitive behaviour by the incumbent.
227. Having considered the views of respondents, TRA remains of the view that structural separation of the incumbent should not be considered in the mean time.

### **7.1 Key milestones of the LLU implementation phase**

#### **Question 9.1**

Do you agree with TRA on the key milestones for the LLU implementation phase?

#### **The March 2009 Consultation Document**

228. In the Consultation Document, TRA proposed the following key milestones for the LLU implementation phase:
- I. The LLU-related general information that will pre-date the LLU RO of Batelco shall be made available by Batelco on simple request and subject to a confidentiality agreement, if reasonably required by Batelco, signed by the OLO by no later than 1 week after the issuance of the Order.
  - II. Batelco shall take all appropriate actions so that the LLU field tests can begin by no later than 15 July 2009. The field tests shall last at least 2 months.
  - III. Batelco shall submit its LLU Reference Offer to TRA for review and approval or ordering by no later than 30 August 2009 (indicative date, subject to entry into force of the Order relating to Unbundling Local Loop, Bitstream and Wholesale DSL).
  - IV. The commercial launch is anticipated by the end of 2009.

#### **Responses to the March 2009 Consultation Document**

229. Kalaam Telecom agrees with the key milestones but suggests that the timing should be slightly delayed to allow more time for OLOs to discuss their requirements with vendors.
230. Lightspeed agree with TRA's proposition.
231. Batelco disagrees with TRA's proposition and believes that the timeframe is not feasible, especially because the following activities are missing:
- a) Service Delivery and Assurance processes development;
  - b) ANFP development and approval;
  - c) Costing exercise and price determination;
  - d) Upgrade of the information systems used for Service Delivery and Assurance, which can last 12 months according to Batelco's experience;
  - e) Upgrade of Batelco's own systems, in particular those related to site preparation (electricity, air-conditioning, partitioning, security).

232. Batelco reminds that:

- It takes more than 12 months to implement complex services in the Reference Offer;
- It took 18 months to implement CPS,
- It took 13 months (between July 2006 and August 2007) to implement Bitstream.

233. Batelco disagrees also with TRA's proposed timeframe for field tests because it believes that field tests should occur after processes have been agreed, because OLOs may need time to get equipment and because it takes time to prepare sites. Batelco considers that it is best practice to have a pilot test for LLU.

### **TRA analysis and conclusion**

234. TRA observes that three types of comments have been expressed by respondents:

- Firstly, on the OLO's side, the fact that the proposed timeframe may be too short for OLOs to discuss their requirements with vendors (Kalaam Telecom);
- Secondly, on Batelco's side, that the proposed timeframe omits some activities and is too short;
- Thirdly, some comments are raised about field tests.

235. First, TRA acknowledges that OLOs may need more time to discuss with vendors the acquisition of equipment. TRA understands that Kalaam Telecom comments relate to field tests. For the LLU commercial launch, this should not be an issue since the commercial launch is planned for the end of 2009, which leaves sufficient time for OLOs to discuss with vendors (Batelco explains that up to 8 weeks can be necessary for equipment selection and delivery lead time). However, TRA is of the view that because the Consultation Document, which was published in late March 2009, discusses the possibility of having field tests, this means that OLOs have about 6 months to discuss with vendors before the start of field tests. TRA understands that OLOs cannot purchase the equipment before the field tests are confirmed (i.e. before the Order is issued) but discussions with vendors can still go on. As a consequence, TRA estimates that 4 weeks after the issuance of the Order is sufficient for OLOs to acquire equipments. This point has been discussed in Question 4.2.

236. Second, TRA disagrees with Batelco's assertion that some activities have not been taken into account in the timeframe:

**a) Service Delivery and Assurance processes development.**

This relates to the writing of the Reference Offer and must therefore be provided by Batelco 2 months after the publication of the Order, according to the Access Regulation<sup>8</sup>. The Access Regulation also states that the Reference Offer must include "conditions for access to ancillary, supplementary and advanced services (including operational support systems, information systems or databases for pre-ordering, provisioning, ordering, maintenance and repair requests)".

**b) ANFP development and approval.**

In addition to the above, the Access Regulation requires that the Reference Offer must include "technical standards for access (including any usage restrictions and other security issues)" (Access Regulation), which includes the ANFP. TRA has already requested the relevant information for the ANFP and acknowledges that such information is available with Batelco. Therefore, TRA is of the view that an initial

---

<sup>8</sup> TRA, Access Regulation, 30 April 2005, Regulation 1 of 2005

version of the ANFP can be published by Batelco to coincide with the beginning of the field tests.

**c) Costing exercise and price determination.**

In addition to the above, the Reference Offer must include “tariffs, terms of payment and procedures for billing, collection and billing disputes”. This means that Batelco must complete the costing exercise and price determination within 2 months. TRA is of the view that the costing exercise and price determination can be completed within the proposed timeframe for LLU implementation.

**d) Upgrade of the information systems used for Service Delivery and Assurance, which can last 12 months according to Batelco’s experience.**

TRA acknowledges that some upgrades of the information systems are necessary for LLU line delivery, for billing and for LLU line fault repair. TRA is of the view that if Batelco relies on its own internal processes used for retail activities (which is mandated by the non-discrimination principle), this activity should only require minimum upgrades. Between the time of issuance of this order and the anticipated time for commercial launch of LLU, TRA considers that Batelco will have between 3 and 6 months to upgrade its systems. TRA believes that since LLU volumes can be expected to be low in the early stages of LLU, a less automated system could be envisaged for these early stages.

**e) Upgrade of Batelco’s own systems, in particular those related to site preparation (electricity, air-conditioning, partitioning, and security).**

TRA anticipates that the commercial launch of the Reference Offer will be towards the end of 2009/ early 2010. This means that Batelco will have more than 3 months to upgrade its own systems. Based on feedback of international experiences, TRA is of the view that this a sufficient period for Batelco to update its own systems especially if it dedicates appropriate resources. TRA notes that Batelco will be allowed to recover efficiently incurred cost. The cost of upgrading Batelco’s own systems should be included in a cost category called “LLU implementation costs” that will be recovered by Batelco

237. Based on the experience of Bitstream and CPS, TRA underlines that it will monitor very closely the implementation of LLU. TRA believes that its review of international experience in LLU implementation will be useful for the implementation of LLU in the Kingdom of Bahrain. As a consequence, the timeframes highlighted by Batelco for Bitstream and CPS implementations are not relevant points of comparison. TRA also considers that the lessons learnt from the implementation of Bitstream and CPS should be useful when it come to the implementation of LLU.

238. Third, regarding Batelco’s comments on the field tests timeframe, TRA has considered this issue in Question 4.2. TRA is of the view that field tests and pilot tests are similar and that the implementation of field tests is sufficient.

239. As a consequence, having considered the views of respondents, TRA considers that the following key milestones for the LLU implementation phase are appropriate:

- I. The LLU-related General Information that will pre-date the LLU RO of Batelco shall be made available by Batelco on simple request and subject to a reasonable confidentiality agreement, if required by Batelco, signed by the OLO by no later than 14 days after the issuance of the Order.
- II. Batelco shall take all appropriate actions so that the LLU field tests can begin by no later than 4 October 2009. The field tests shall last at least 6 weeks.

- III. Batelco shall submit its LLU Reference Offer to TRA for review and approval or ordering within 3 months of the Dominance Determination
- IV. The commercial launch of LLU to all OLOs must occur no later than 14 days from the date TRA approves or orders Batelco's LLU RO.

## **Annex C**

### **Study on the Regulation of Wholesale Broadband Markets**



هيئة تنظيم الاتصالات  
Telecommunications Regulatory Authority

## **Final Study on the Regulation of Wholesale Broadband Markets**

**A Study issued by the Telecommunications Regulatory Authority  
of the Kingdom of Bahrain**

14 September 2009

**Purpose:** To define the appropriate set of regulated wholesale products for wholesale broadband markets.

## Table of contents

List of acronyms .....	97
1 Introduction.....	99
2 Background to this study .....	100
3 Appropriate access remedies in wholesale broadband markets.....	101
4 Assessing whether it is no more than is appropriate and necessary to impose upon Batelco an obligation to provide LLU to address the market failure identified .....	118
5 Other comments from respondents.....	140
Annex A: Benchmarks of Retail Broadband Offers .....	142
Annex B: Domestic Benchmarks of Retail Broadband Offers.....	149
Annex C: LLU and Bitstream chronology in some smaller countries .....	151

## List of acronyms

ADSL	Asymmetric Digital Subscriber Line
ARCEP	Autorité de Régulation des Communications Electroniques et de la Poste (French telecommunications regulator)
BD	Bahraini Dinar
CBA	Cost-Benefit Analysis
ComReg	Commission for Communications Regulation (Irish telecommunications regulator)
DSL	Digital Subscriber Line
DSLAM	Digital Subscriber Line Access Multiplexer
EC	European Commission
ECTA	European Competitive Telecommunications Association
ERG	European Regulators Group
ETNO	European Telecommunications Network Operators' Association
EU	European Union
EU15	European Union with 15 countries (Austria, Belgium, Denmark, Finland, France, Germany, Greece, Ireland, Italy, Luxembourg, Netherlands, Portugal, Spain, Sweden, UK)
EU27	European Union with 27 countries (countries above plus Bulgaria, Cyprus, Czech Republic, Estonia, Latvia, Lithuania, Malta, Hungary, Poland, Romania, Slovakia, Slovenia)
FCC	Federal Communications Commission
FTTx	Fibre-to-the-x
FTTB	Fibre-to-the-Home
FTTH	Fibre-to-the-Building
FWA	Fixed Wireless Access
GCC	Gulf Cooperation Council
GSM	Global System for Mobile communications
IP	Internet Protocol
LLU (or ULL)	Local Loop Unbundling (or Unbundling of the Local Loop)
LTE	Long-Term Evolution
MDF	Main Distribution Frame
MPLS	Multiprotocol Label Switching
MSAN	Multi Service Access Node
NFWS	National Fixed Wireless Services
NGN	Next Generation Network
NGA	Next Generation Access networks
NRA	National Regulatory Authority

OECD	Organisation for Economic Co-operation and Development
Ofcom	Office of Communications (UK telecommunications regulator)
OLO	Other Licensed Operators
OPTA	Independent regulator of post and electronic communications
PSTN	Public Switched Telephone Network
RAO	Reference Access Offer
SKMM	Malaysian Communications and Multimedia Commission
SMP	Significant Market Power
SRMR	Strategic and Retail Market Review
SSNIP	Small but Significant Non-transitory Increase
TRA	Telecommunications Regulatory Authority of the Kingdom of Bahrain
TRC	Telecommunication Regulatory Commission in Jordan
UK	United Kingdom
UMTS	Universal Mobile Telecommunications System
USA	United States of America
WSDSL	Wholesale DSL

# 1 Introduction

1. In defining appropriate remedies in wholesale markets in which Batelco has been found dominant, TRA seeks to promote competition for the long-term benefits of end-users while providing an environment conducive to efficient investment by Batelco and OLOs.
2. In its Dominance Determination on Wholesale Broadband Markets<sup>1</sup>, TRA has identified the following market failures:
  - a) Batelco is dominant in the wholesale physical network infrastructure access market in the Kingdom of Bahrain; and
  - b) Batelco is dominant in the wholesale market for broadband access in the Kingdom of Bahrain.
3. The purpose of this study is to determine appropriate wholesale remedies to address these market failures. According to Article 3.5 of the Access Regulation issued on 30 April 2005, possible access remedies are:
  - a) Wholesale DSL (Article 3.5(d));
  - b) unbundled local loops (Article 3.5(e));
  - c) main distribution frames or concentrators for Bitstream access or DSL collocation (Article 3.5(f)).
4. Batelco currently offers a Bitstream product (corresponding to Article 3.5(f)) and Wholesale DSL (corresponding Article 3.5(d)) to OLOs in the Kingdom of Bahrain, but not LLU (which would correspond to Article 3.5(e)).
5. In this study, TRA identifies the appropriate access remedies with respect to wholesale services in the wholesale broadband markets. TRA is of the view that LLU and Bitstream are complementary products that ought to be provided by the incumbent. TRA also considers that the regulation of Wholesale DSL may no longer be necessary once LLU and Bitstream are in place subject to appropriate safeguards.
6. TRA also assesses whether it is no more than is appropriate and necessary to impose upon Batelco an obligation to provide LLU. As Bitstream is already provided by Batelco, a study of the matters indicated under Article 3.7 of the Access Regulation issued on 30 April 2005 is required only for the introduction of LLU.
7. Ultimately TRA determines that having considered the views of the respondents, TRA remains of the view that it is no more than appropriate and necessary to address the market failure identified to impose upon Batelco an obligation to provide LLU.

---

<sup>1</sup> TRA, "Dominance Determination in Wholesale Broadband Markets", 14 September 2009 (Reference MCD/09/09/064)

## **2 Background to this study**

8. TRA issued a draft study on 26 March 2009 on the “Regulation of Wholesale Broadband Markets” (the “March 2009 Study”) (Ref. MCD/03/09/019).
9. TRA received responses from Bahrain Telecommunications Company B.S.C. (“Batelco”), Lightspeed Communications W.L.L. (“Lightspeed”) and 2Connect.
10. For clarity purposes, the final study largely reproduces the text included in the March 2009 Study, with minor amendments, before summarising and addressing the comments received on the March 2009 Study and reaching its final conclusions. . The response from 2Connect which was received after the closing time and was therefore not considered.
11. TRA reviews the answers to the seven questions it has asked the industry in the March 2009 Study and then considers additional comments raised by Batelco in its response.

### **3 Appropriate access remedies in wholesale broadband markets**

12. Having regard to the characteristics of the various wholesale products along the broadband value chain, international experience, expected market development and the imperative for regulation to focus on bottlenecks and to be as minimal as possible, TRA is of the view that
  - a) LLU should be introduced;
  - b) Bitstream should remain in place; and
  - c) Wholesale DSL may, as a regulated product, be phased out subject to appropriate safeguards.
13. In its Dominance Determination, TRA has identified the following market failures:
  - a) Batelco is dominant in the wholesale physical network infrastructure access market in the Kingdom of Bahrain; and
  - b) Batelco is dominant in the wholesale market for broadband access in the Kingdom of Bahrain.
14. In other words, in the absence of regulation, Batelco would not be sufficiently constrained from behaving independently of its competitors, subscribers and, ultimately, users such that prices would be constrained in the relevant markets. There are many types of market failures, and market power is one of the most relevant in the context of regulatory and competition policy.
15. As a dominant operator, Batelco may be required, under Article 3.5 of the Access Regulation issued on 30 April 2005, to provide various access services in relation to the following telecommunications network elements or telecommunications facilities directly relevant to broadband services:
  - a) Wholesale DSLs (Article 3.5(d));
  - b) unbundled local loops (Article 3.5(e));
  - c) main distribution frames or concentrators for Bitstream access or DSL collocation (Article 3.5(f)).
16. All of these access services are wholesale services enabling OLOs to provide broadband Internet access services to end-users.
17. Batelco currently offers a Bitstream product (corresponding to Article 3.5(f)) and Wholesale DSL (corresponding Article 3.5(d)) to OLOs in the Kingdom of Bahrain, but not LLU (which would correspond to Article 3.5(e)).
18. TRA notes that there is demand for LLU. Interviews conducted by TRA with alternative operators in November 2008 have indicated that there is potential demand from alternative operators for having access to the local loop: five operators have expressed their interest in LLU, and four of them expressed their wish to see an LLU product available as soon as possible.
19. LLU is a product under which Batelco's copper local loops would be connected to the core network of an OLO to be used for its own broadband and connectivity services.
20. Bitstream is a product by which Batelco provides transmission capacity from end-users to a core network point in such a way as to allow an OLO to offer its own broadband services. Contrary to LLU, where OLOs have access to a passive link (i.e. the copper

local loop) and have to deploy and manage their own active exchange equipment (including but not limited to DSLAM/MSAN) in the incumbent's Service Nodes/MDFs, Bitstream provides OLOs with access to an active link, and exchange equipment has to be managed by Batelco.

21. With Wholesale DSL, OLOs merely resell the retail DSL offers developed by Batelco for its end-users: the level of network investment required by OLOs is minimal, as shown in Figure 1 below.

**Figure 1 - Relative level of network investment required by OLOs with LLU, Bitstream and Wholesale DSL**

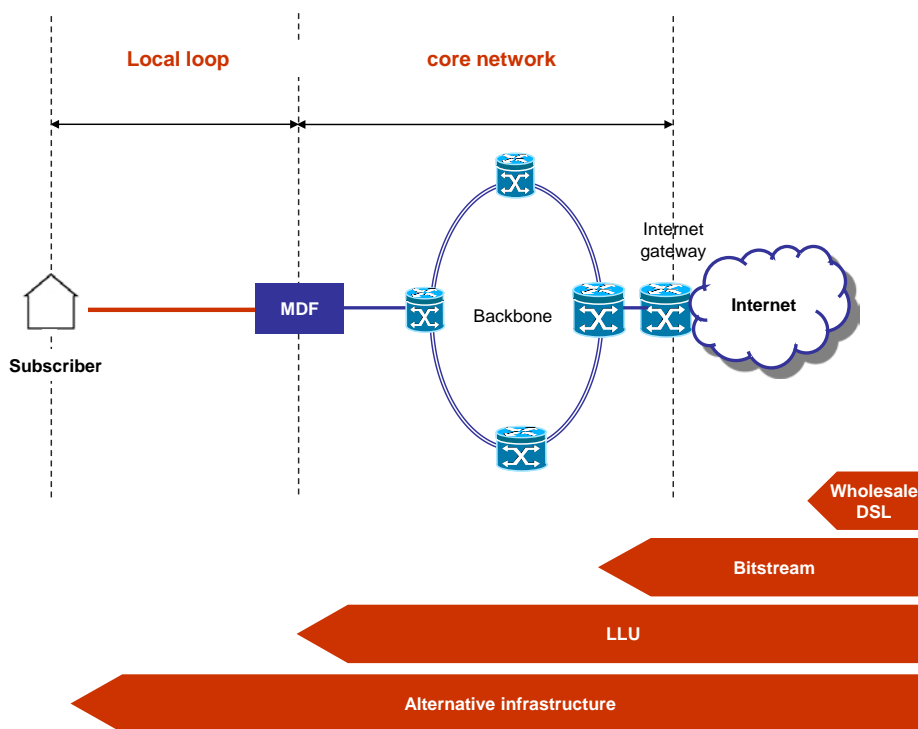

### 3.1 LLU and Bitstream are complementary wholesale products

#### Question 1

Do you agree with TRA's opinion that LLU and Bitstream are complementary wholesale products required in order to promote competition? Please elaborate.

#### The March 2009 Study

22. In its Strategic and Retail Market Review ("SRMR") Statement, TRA concluded that LLU and Bitstream were complementary products: "TRA considers LLU to be a complementary and not a substitute access product to Bitstream and Wholesale DSL".<sup>2</sup>
23. In the following, TRA articulates the different layers of complementarities between LLU and Bitstream which are:
- a) Having LLU and Bitstream in place enables more diversified (and, ultimately, stronger) competition, as OLOs can choose between LLU and Bitstream depending on their product strategy and financing capabilities;
  - b) Having LLU and Bitstream in place enables OLOs to phase their investments in the roll-out of their network over time (temporal complementarities), as a complete LLU roll-out is time-consuming and not achievable in the short term;
  - c) Having LLU and Bitstream in place enables OLOs to offer their services all over the country (geographical complementarities), as LLU is unlikely to be profitable in all Service Nodes.

#### *Having LLU and Bitstream in place enables more diversified competition*

24. TRA underlines that although LLU allows greater independence from the incumbent, it also requires major investment from OLOs (related to backhaul and exchange equipment). LLU is sensitive to economies of scale/densities and is therefore profitable once the number of customers at the Service Node level is sufficient. By contrast, economies of scale/density for Bitstream-based entry play a much less significant role in Bahrain because the required investment by OLOs is much lower and the costs paid to Batelco are mainly variable costs.<sup>3</sup>

---

<sup>2</sup> TRA, "Statement on the Strategic and Retail Market Review", 3 June 2008, page 7.

<sup>3</sup> With the exception of the current minimum charge per month, as per the Bitstream reference offer. The current minimum charges include: "Fee to establish Bitstream service relation"; and "Maintaining relationship charge" (Batelco's Bitstream service description - <http://www.batelco.com/reference.asp>).

25. As a consequence, with both LLU and Bitstream available, OLOs have a greater choice for their development strategy: LLU offers higher flexibility and requires higher investment, while Bitstream offers lower flexibility but requires lower investment. This has been highlighted by the European Commission (“EC”) as well: <sup>4</sup>

*“Unbundled loops typically give greater flexibility and control over the retail broadband service offered to the end-user and have typically been supplied at the main distribution frame (MDF). In contrast, wholesale broadband access in the form of a bit-stream service typically gives less flexibility over the retail service, and may be supplied at higher points in the network (such as regional interconnection points), as well as at the MDF.”*

***Having LLU and Bitstream in place enables OLOs to phase their investments in network roll-out over time (temporal complementarities)***

26. Because of the higher barriers to entry for OLOs with LLU than with Bitstream, TRA believes that some OLOs may first prefer to acquire end-users on the basis of Bitstream and then, once they have built up a market share and a critical mass of customers, invest in LLU.<sup>5</sup>
27. The European experience illustrates this kind of temporal complementarities: “In many Member States there is a trend towards migration between different wholesale products, mainly from resale and Bitstream towards LLU.”<sup>6</sup> Bitstream and LLU are thus complementary in time.
28. These complementarities in time have been highlighted in the investment ladder notion developed by Martin Cave,<sup>7</sup> where LLU is at the top (as shown in
29. Figure 2 - Broadband value chain described by Martin Cave below). Martin Cave states that:

*“The key is the encouragement of investment both by the historic monopolist and by entrants. The latter may have to acquire capital assets progressively, as they acquire customers and revenues. This approach has been likened to climbing a ‘ladder of investment’, which should culminate in a high level of competition across the value chain. Achieving extensive competition of this kind has the inestimable advantage of making the next generation of technology contestable – in effect creating a race among the competitors to implement it.”*

30. In the case of the broadband value chain, the Bitstream product enables OLOs to acquire customers progressively, generating revenues that will enable them to deploy backhaul and buy active exchange equipment (including but not limited to DSLAMs/MSANs) in order to unbundle lines (as indicated in Figure 3 - Broadband value chain and optimal broadband regulatory model).

---

<sup>4</sup> “Commission Staff Working Document, Explanatory Note. Accompanying document to Commission Recommendation on Relevant Product and Service Markets within the Electronic Communications Sector Susceptible to *ex ante* Regulation in Accordance with Directive 2002/21/EC of the European Parliament and of the Council on a Common Regulatory Framework for Electronic Communications Networks and Services”.

<sup>5</sup> These temporal complementarities could be considered to be of even greater relevance in times of more constrained capital markets.

<sup>6</sup> “Commission Staff Working Document Accompanying the Communication from the Commission to the European Parliament, the Council, the European Economic and Social Committee and the Committee of the Regions – Progress Report on the Single European Electronic Communications Market 2007 (13th report)”.

<sup>7</sup> “Making the ladder of investment operational”, Martin Cave, November 2004.

Figure 2 - Broadband value chain described by Martin Cave

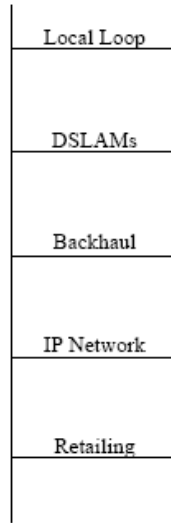

Source: "Making the Ladder of Investment Operational", Martin Cave, November 2004

Figure 3 - Broadband value chain and optimal broadband regulatory model

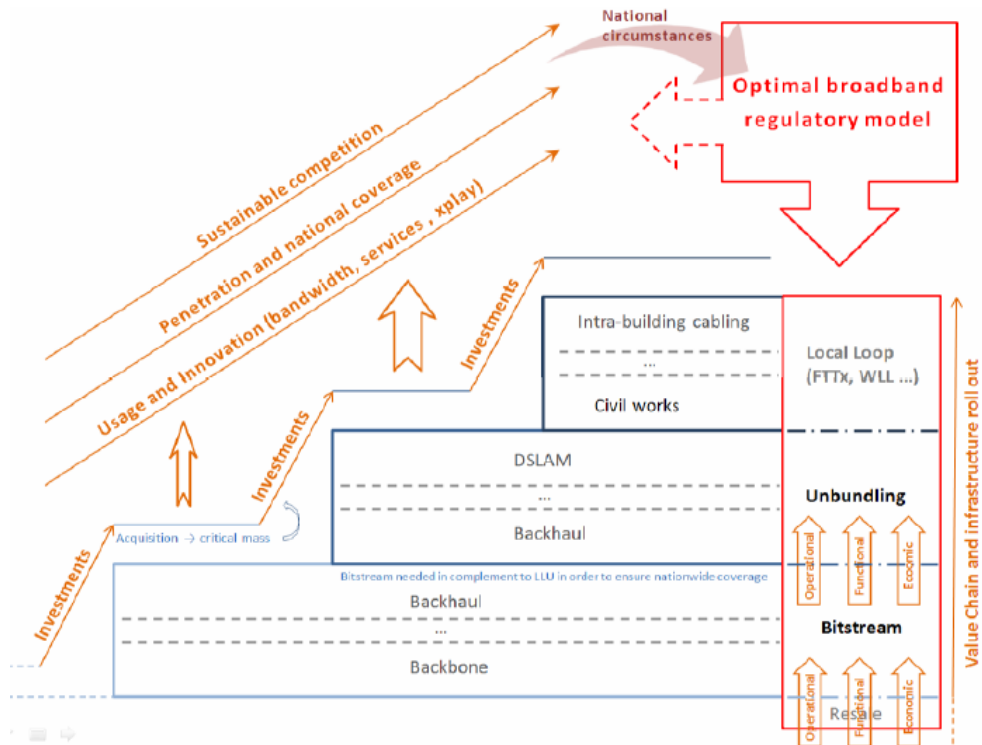

Source: ITU

**Having LLU and Bitstream in place enables OLOs to offer their services all over the country (geographical complementarities)**

31. TRA observes, furthermore, that OLOs cannot unbundle all of the Service Nodes in a given country in the medium term (or, at least in some cases, at all). In large European countries in which LLU has been implemented for eight years, it is observed that OLOs have not unbundled the smallest Service Nodes yet. Because of the economies of scale (as shown in Figure 4 - Level of economies of scale per Service Node (or MDF) below), it is indeed unlikely that all Service Nodes can be profitable for OLOs in the medium term. As a consequence, in the medium term, if only LLU were available, competition would be encouraged only in certain areas. Some areas would still remain with only one DSL operator.
32. This also implies that OLOs would not be able to develop national retail offers. However, if both LLU and Bitstream were available, OLOs would be able to have coherent retail offers available throughout the country.

**Figure 4 - Level of economies of scale per Service Node (or MDF)**

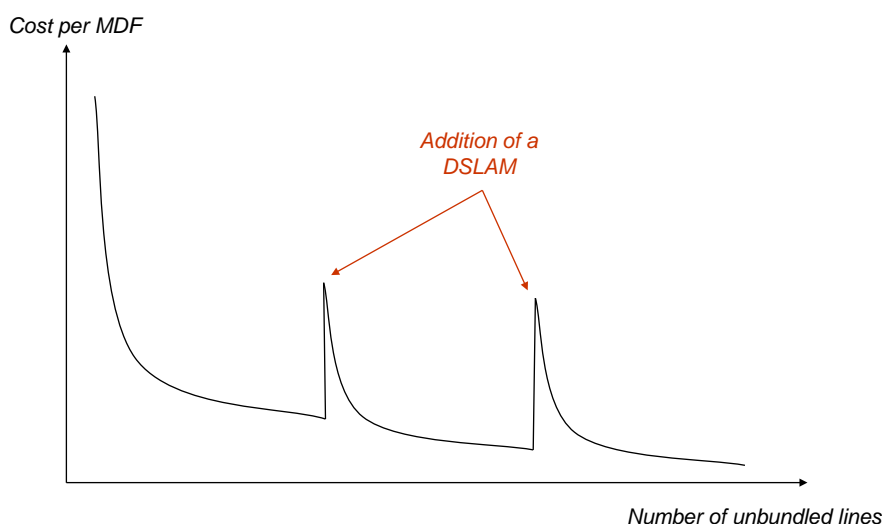

33. TRA foresees that, because of the importance of these economies of scale, which are a distinctive feature of the economics of unbundling in every country, OLOs will initially unbundle large Service Nodes.
34. Looking at the development of LLU in France (see Figure 5 - Development of LLU coverage in France, 2003–2008 below), TRA notes that OLOs first unbundled large Service Nodes, with the highest number of lines per MDF, in order to get the largest economies of scale and then unbundled smaller Service Nodes, with a lower number of lines per MDF. At the end of 2003 the smallest unbundled MDF had around 16,000 lines (around 400 MDFs had been unbundled). This number decreased to around 6,000 lines at the end of 2005. By the end of 2008, OLOs demonstrated that it was efficient to unbundle MDFs with less than 1,600 working lines, covering almost 75% of the total population with LLU.

**Figure 5 - Development of LLU coverage in France, 2003–2008**

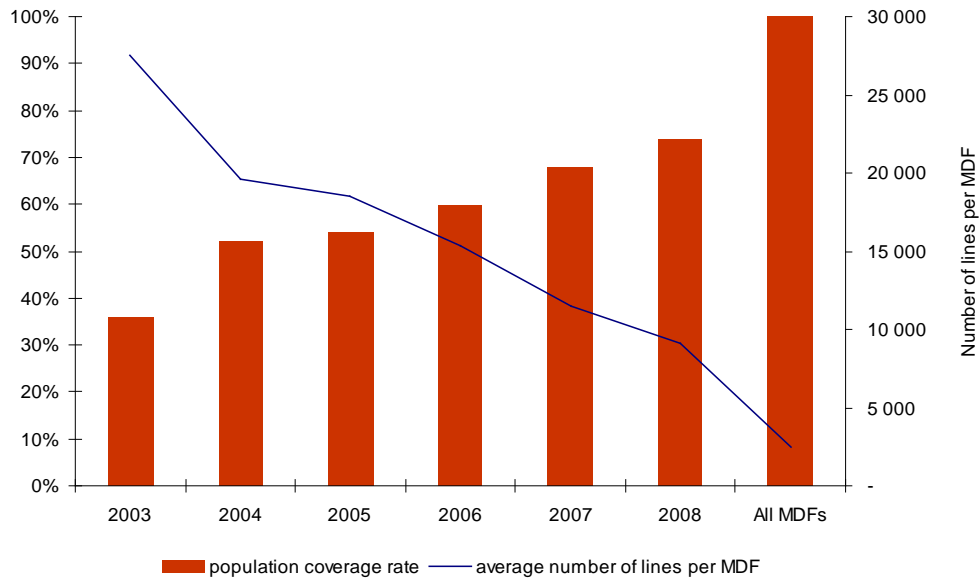

**Source: ARCEP data, 2008**

35. Comparing the number of lines per MDF in France and in the Kingdom of Bahrain, TRA considers that the level of economies of scale achievable should be high in the Kingdom of Bahrain. To cover between 65% and 75% of the total population with LLU, the smallest unbundled Service Nodes (or MDF) would have twice as many lines compared to France, although the average size of unbundled MDFs in the two countries would be similar (see Figure 6 below). This is likely to be explained by the very high population density and geographic concentration of the population in Bahrain.

**Figure 6 - Local loop distribution in France and Bahrain, 2003–2008**

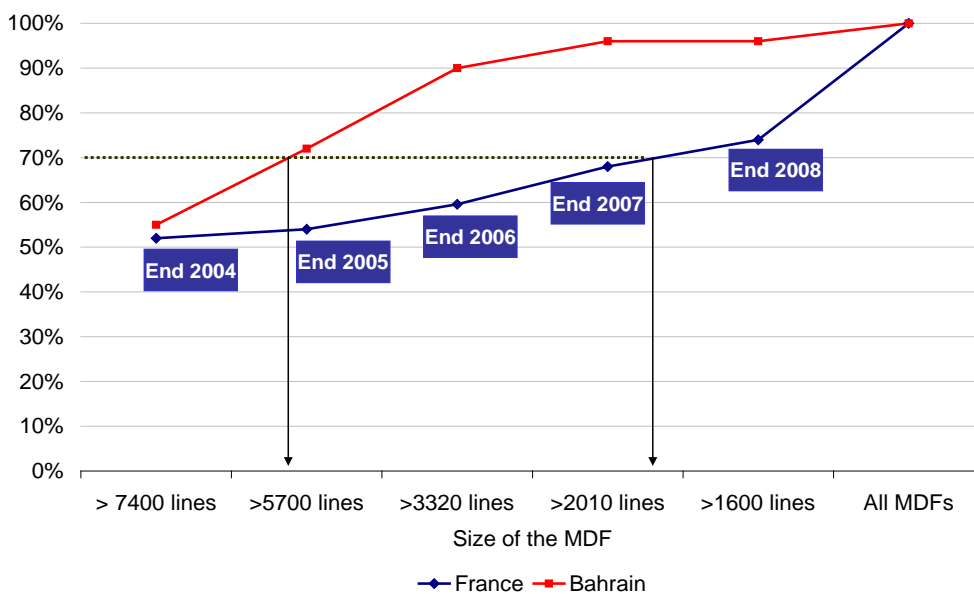

**Source: ARCEP data and TRA data, 2008**

36. Competition does not generally work well when only LLU is available, in particular outside densely populated areas. Commenting on the German case, the European Commission (“EC”) stated: <sup>8</sup>

*“The case of Germany demonstrates this particularly well as here, Bitstream access has been refused for years. As a result of this, the dominance of Deutsche Telekom is particularly high in non-metropolitan areas, which has led to substantially higher prices for broadband connections there.”*

37. Another quote, from the Italian regulator, illustrates why Bitstream is a necessary and appropriate complementary wholesale product to LLU for nationwide competitive offers.<sup>9</sup>

*“Although AGCOM originally considered LLU the main form of access, it soon realized that the market dynamics advanced the implementation of LLU too much and thus also mandated a Bitstream offer, which is also deemed the necessary complement for LLU providers in areas with less population density”.*

38. Furthermore, TRA notes that, in 22 countries of the EU27, there are agreements on both LLU and Bitstream products between one or some OLOs and the incumbent.<sup>10</sup> These 22 countries include smaller countries like Slovenia (around 2 million inhabitants), Luxembourg (around 480,000 inhabitants), Latvia (around 2.3 million inhabitants) and Lithuania (around 3.3 million inhabitants). TRA notes also that in other regions of the world, such as New Zealand,<sup>11</sup> both LLU and Bitstream are available.
39. For the reasons set out above, TRA considers that LLU and Bitstream are required complementary wholesale products.

### **Responses to the March 2009 Study**

40. Lightspeed agrees with TRA’s view.
41. Batelco disagrees with the three levels of complementarities identified by TRA.
42. Contrary to TRA’s argument that “Having LLU and Bitstream in place enables more diversified competition”, Batelco considers that TRA stated in paragraphs 18 and 19 of the March 2009 Study that LLU is insufficient to provide diversified competition as it requires major investment from OLOs and it is sensitive to economies of scale. Batelco adds that Bitstream is superior to LLU and is suitable for the interim period, while broadband and NGN markets develop in Bahrain.
43. Contrary to TRA’s argument that “Having LLU and Bitstream in place enables OLOs to phase their investments in network roll-out over time (temporal complementarities)”, Batelco responded that, while LLU and Bitstream may have been complementary

---

<sup>8</sup> European Commission, Memo, 21 August 2006.

<sup>9</sup> ERG, “Broadband Market Competition Report”, 2005.

<sup>10</sup> “Commission Staff Working Document Accompanying the Communication from the Commission to the European Parliament, the Council, the European Economic and Social Committee and the Committee of the Regions – Progress Report on the Single European Electronic Communications Market 2007 (13th report)”.

<sup>11</sup> <http://www.comcom.govt.nz/IndustryRegulation/Telecommunications/StandardTermsDeterminations/UnbundledLocalLoopService/DecisionsList.aspx>

products in the legacy PSTN world of the late 1990s under the ladder of investment theory, this is not the case today, with the development of broadband and NGN. Consequently, it cannot be argued anymore that having Bitstream and LLU will enable OLOs to phase their investment. To illustrate these points, Batelco extensively referred to quotes from various commentators, including R. Nicholls and M. Cave, and the ETNO.

44. Batelco also refers to the cases of the USA, the UK and Canada, where the ladder of investment has arguably not proven to be correct because OLOs were not necessarily phasing their investments in network roll-out over time.<sup>12</sup>
45. Batelco adds, furthermore, that Malaysia, New Zealand and Jordan have decided to mandate Bitstream initially, at least for an interim period, after having reviewed the literature and international experience of regulating LLU and Bitstream.
46. Contrary to TRA's argument that "Having LLU and Bitstream in place enables OLOs to offer their services all over the country (geographical complementarities), as LLU is unlikely to be profitable in all Service Nodes)", Batelco considers that the Bitstream product has developed significantly over recent years and that, with the growth of broadband and NGNs, it is actually able to provide access all over the country. Batelco believes that Bitstream is a superior product to LLU, especially in providing access to mass-market residential customers based on:
  - a) the ERG statement that *"the provision of Bitstream access is essential to the development of competition in the wholesale broadband access market as well as in the retail services market [and] NRAs should mandate this access product"*,<sup>13</sup>
  - b) the observation that 86% of wholesale lines in Australia and 99.3% in the UK are Bitstream lines (however, Batelco does not provide references for these figures);
  - c) an FCC statement saying that the FCC is not aware of any new entrant who uses LLU to serve mass-market customers (however, Batelco does not specify when the FCC stated this and does not provide the reference to this statement).
47. Batelco concludes that LLU and Bitstream are no longer complementary products and that it is necessary and appropriate to regulate Bitstream only and not LLU for an interim period of two years while the broadband and NGN markets develop in Bahrain. After that period, the need to regulated LLU should be reassessed.

## **TRA analysis and conclusion**

### ***Having LLU and Bitstream in place enables more diversified competition***

48. In response to Batelco's disagreement with the TRA's view that "Having LLU and Bitstream in place enables more diversified competition", Batelco has misinterpreted TRA's statements in the March 2009 Study. According to Batelco, *"TRA have stated in paragraphs 18 and 19 of the March 2009 Study that LLU is insufficient to provide diversified competition as it requires major investment from OLOs and it is sensitive to economies of scale"*.

---

<sup>12</sup> Hausman J., & Sidak G., "Did Mandatory Unbundling Achieve its Purpose? Empirical Evidence from Five Countries", *Journal of Competition Law and Economics* 1(1), 173-245.

<sup>13</sup> ERG Consultation Document, "Bitstream Access", 14 July 2003.

49. While TRA agrees that LLU requires investment and is sensitive to economies of scale, TRA disagrees that these points prevent LLU from providing diversified competition. The necessity to invest and the sensitivity of LLU to economies of scale imply merely that it takes more time to achieve returns on investment with LLU compared to Bitstream and that only OLOs with sufficient financial and operational capacities can undertake LLU. Consequently, having only LLU, compared to Bitstream and LLU, would imply that benefits from diversified competition would be delayed.
50. It is also important to note that LLU enables OLOs to differentiate their services significantly from those of the incumbent, since it allows the introduction of new retail services (such as voice over DSL services, video on demand services or IPTV services), without having to wait for the incumbent to include them in its Bitstream product, should it wish to do so. LLU also provides more flexibility to OLOs.
51. Therefore TRA remains of the view that having LLU and Bitstream in place enables more diversified (and ultimately more intense) competition, as OLOs can choose between LLU and Bitstream depending on their product strategy, operational and financing capabilities.

***Having LLU and Bitstream in place enables OLOs to phase their investment in network roll-out over time (temporal complementarities)***

52. Before addressing Batelco's statement that the investment ladder and LLU are no longer appropriate with the development of broadband and NGN, it is useful to clarify the concepts of NGN and NGA:
  - a) NGN (Next Generation Network) refers to the core network;<sup>14</sup>
  - b) NGA (Next Generation Access) refers to the access network.<sup>15</sup>
53. TRA acknowledges that LLU could be inappropriate in an NGA environment depending on the network architecture. Where fibre is deployed with a point-to-point architecture, it can be unbundled. However, if fibre is deployed up to the home or up to the cabinet, it is (at least, given the current state of fibre technology) not possible to unbundle fibre at the Service Node. From a technical point, LLU cannot exist on a NGA network as it is presently implemented on the copper local loop. This is due to the fact that a single fibre is carrying the traffic for several end-users, and this makes the unbundling of a fibre very difficult. Similar technical constraints occur with wireless technologies. In this respect, TRA fully agrees with R. Nicholls's and M. Cave's statements quoted by Batelco<sup>16</sup>. TRA notes that the extensive references to NGA by Batelco and the question

---

<sup>14</sup> The ERG proposes a definition of NGN: "A packet-based network able to provide telecommunication services and able to make use of multiple broadband, QoS-enabled transport technologies and in which service-related functions are independent from underlying transport-related technologies. It offers unrestricted access by users to different service providers. It supports generalized mobility which will allow consistent and ubiquitous provision of services to users." Source: ERG, ERG Opinion on Regulatory Principles of NGA, ERG (07) 16rev2.

<sup>15</sup> The ERG proposes a definition of NGA: "As the term NGN is often used as a catch-all phrase with regard to access networks, a NGA network is generally meant to be a packet switching (IP)-based access network reaching from multi-functional access and aggregation nodes to the end-users. Such a NGA network can be made of fibre, copper utilizing xDSL technologies, coaxial cable, powerline communications, wireless technologies, or hybrid deployments of these technologies, e.g. combining fibre and copper." Source: ERG, ERG Opinion on Regulatory Principles of NGA, ERG (07) 16rev2.

<sup>16</sup> See Batelco submission to TRA for "TRA Study On The Regulation Of Wholesale Broadband Market", 7 May 2009

of the appropriate wholesale products in that environment are to a large extent beyond the timeframe of analysis of this study as Batelco currently does not have any NGA plans. Further, it would take time for Batelco to deploy a NGA network with significant coverage (several years, according to international experience, as explained by TRA in the Dominance Determination)<sup>17</sup> from the moment it decides to deploy such a network. As a consequence, TRA remains of the view that LLU is a key wholesale product for the time being, when Batelco has no NGA network.

54. Further, TRA considers that LLU has the potential to facilitate competition in a NGA environment. Investments made by OLOs for LLU in order to access Batelco's Service Nodes are likely to constitute an enabler for competition in a NGN/NGA environment. For example:
- a) Fibre backhaul deployed for LLU could easily be re-used in a NGA environment,
  - b) Today's MSANs are able to manage both fibre and copper links, which means that OLOs would be able to invest in equipments that could be used in an NGA environment.
  - c) In a NGA environment Batelco's Service Nodes are likely to remain key network points.
55. Given that Batelco has no NGA plans at this stage and that TRA is aware of, and considering the time required for deploying NGA both for Batelco and for OLOs, and given the fact that Batelco's current Service Nodes locations are likely to remain key network points in the future, TRA remains of the view that having both bitstream and LLU is appropriate.
56. With respect to Batelco's reference to a document published by ETNO (an association of European incumbents), TRA notes that it constitutes one view amongst others and that this somewhat out-dated contribution by ETNO to an ERG report<sup>18</sup> did not result in any change to the ERG final report.
57. Regarding Batelco's reference to the case of the USA, the UK and Canada where, according to Batelco, the ladder of investment has not been observed because OLOs were not necessarily phasing their investments in network roll-out over time, TRA observes that the USA and Canada are two jurisdictions where there is a large number of incumbent local operators, which may make nationwide introduction and monitoring of LLU and Bitstream more complicated. TRA also notes that this study is based on old data going all the way back to 2002 and 2003, a time at which LLU was not fully effective and its full impact had yet to be felt. There is also a large number of counter examples which suggests that alternative operators have benefited of the complementarities between bitstream and LLU and have phased their investments in network roll-out over time, including:
- a) In France, alternative operators such as Free or SFR used to rely initially on Bitstream and then purchased LLU and are now deploying fibre networks;
  - b) In Germany, alternative operators such as NetCologne, Mnet, Hansenet and Wilhelm.tel are proposing DSL services based on the incumbent's local loop, and all have plans to deploy fibre networks;<sup>19</sup>

---

<sup>17</sup> See the section on the definition of the wholesale physical network infrastructure access market

<sup>18</sup> "Broadband Market Competition Report" [ERG(05)23]

<sup>19</sup> <http://www.digiworldsummit.com/2007/UserFiles/File/06%20Frank%20SCHMIDT.ppt#291,4>, New competition in the local loop.

- c) In the UK, where LLU is very successful, with 5.2 million LLU lines, i.e. 32% of all broadband lines (TRA notes that Batelco's statement about the UK dates back to 2004 and is no longer appropriate), Sky and Carphone Warehouse, two of the major LLU operators, are "*privately showing interest in using a sub-loop unbundling product*";<sup>20</sup> which shows that they intend to climb further the investment ladder.
58. Regarding Batelco's comments on the approach taken in Malaysia, New Zealand and Jordan where Bitstream was mandated initially for an interim period, after which LLU was considered, TRA believes that TRA's proposed approach is consistent with these countries. In particular, TRA observes that the timing between Bitstream being mandated and LLU being mandated in Bahrain is similar to the process applied in New Zealand and Jordan:
- a) In New Zealand, two years elapsed between Bitstream being mandated (May 2004) and LLU being mandated (December 2006);
  - b) In New Zealand, two-and-a-half years elapsed between Bitstream being launched (March 2005) LLU being launched (November 2007);
  - c) In Jordan, three years elapsed between Bitstream being mandated (March 2005) and the consultation document about LLU launch being published (May 2008);
  - d) In Bahrain, three-and-a-half years elapsed between Bitstream being mandated (early 2006) and LLU being mandated (July 2009);
  - e) In Bahrain, it is expected that it will take around two-and-a-half years between Bitstream being launched (June 2007) and LLU being launched (expected end of 2009).

*NB:* see Annex C: LLU and Bitstream chronology in some smaller countries for more details.

59. TRA adds that countries such as Cyprus or Slovenia, which are small countries like the Kingdom of Bahrain, and which have considered the regulation of LLU and Bitstream recently (respectively in 2005/06 and 2003), have both decided to mandate LLU and Bitstream at the same time (and even with LLU mandated before Bitstream).
60. TRA remains therefore of the view that having LLU and Bitstream in place enables OLOs to phase their investment in network roll-out over time (temporal complementarities).

***Having LLU and Bitstream in place enables OLOs to offer their services all over the country (geographical complementarities)***

61. Whilst TRA agrees with Batelco's statement that Bitstream is available throughout the country, when TRA states that Bitstream and LLU have geographic complementarities, it means that Bitstream can complement LLU coverage and not the opposite.
62. TRA considers that the evidence presented by Batelco to support its view that Bitstream is superior to LLU for serving mass-market residential customers is unconvincing and outdated. TRA notes in particular that:
- a) In the EU15, there were 27 million LLU lines in January 2009, comprising 27% of the total number of broadband lines, while Bitstream lines accounted for 6% of total broadband lines (See Figure 7 below).

---

<sup>20</sup> <http://www.ofcom.org.uk/telecoms/discussnga/pressspeech/ethacc.pdf>.

- b) The figures provided by Batelco for the UK are outdated. In January 2009, there were 5.5 million LLU lines in the UK, comprising 32% of the total number of broadband lines, while Bitstream lines accounted for 4% of total broadband lines.
- c) In Germany, France and Greece, LLU lines account for around 35% of total broadband lines, while Bitstream lines account for, respectively, 4%, 12% and 4%.
- d) In Slovenia and Cyprus, which are smaller countries in which LLU has been launched more recently, 17% of all broadband lines are LLU lines. There were respectively 73,000 and 24,000 LLU lines in January 2009 in these countries for, respectively, 2 million and 700,000 inhabitants whilst Bitstream lines accounted for respectively 18,500 lines and 200 lines in January 2009.

**Figure 7 - Evolution of LLU lines, Bitstream lines and Bitstream+Resale lines in the EU15**

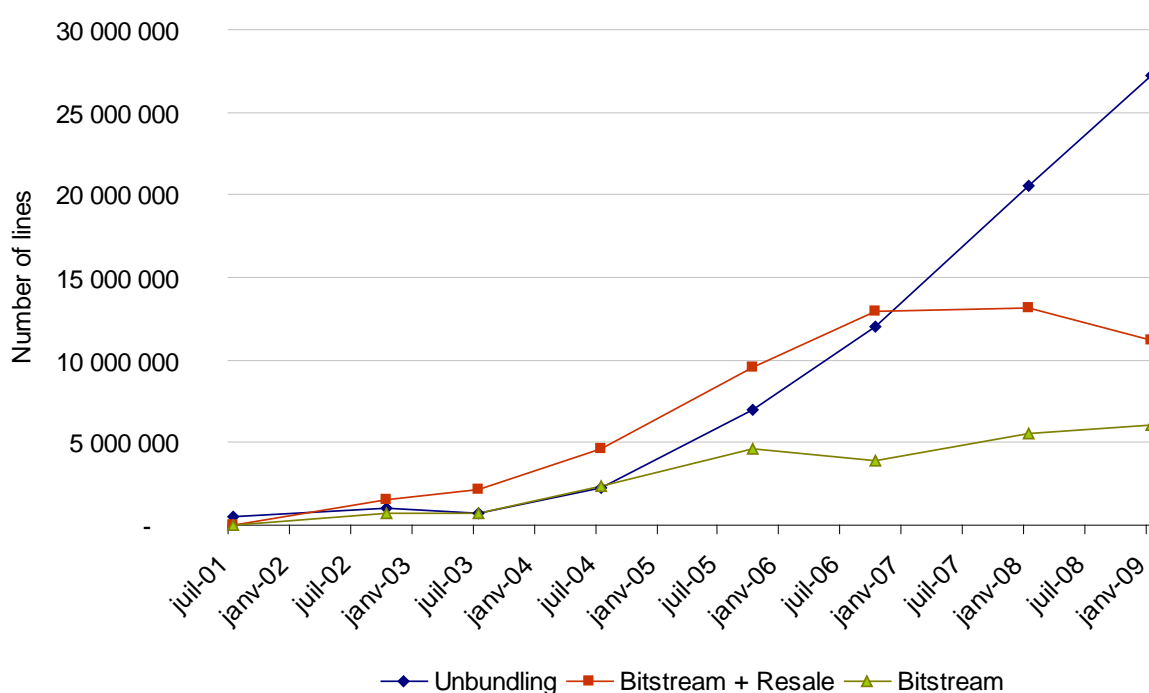

**Source: TRA from European Commission**

- 63. More recent data shows that LLU operators, including those operating in small countries, make extensive use of LLU to address the retail broadband market. If bitstream was superior, as advocated by Batelco, then the number of bitstream lines would be significantly greater than the number of LLU lines and not the contrary.
- 64. TRA remains therefore of the view that having LLU and Bitstream in place enables OLOs to offer their services all over the country (geographical complementarities).
- 65. TRA also believes that Batelco's proposition to regulate only Bitstream and not LLU for an interim period of two years while the broadband and NGN markets develop in Bahrain is not desirable, since it would unnecessarily delay the strengthening of competition

66. Having considered the views of the respondents, and in particular having considered that the LLU product remains desirable even in the context of NGN/NGA development, TRA remains of the view that LLU and Bitstream are complementary wholesale products required in order to promote competition.

### 3.2 Having LLU and Bitstream in place, the regulation of Wholesale DSL is no longer necessary and should be phased out

#### Question 2

Do you agree with TRA's opinion that, having LLU and Bitstream in place, regulation of Wholesale DSL is no longer necessary, subject to appropriate safeguards? Please elaborate.

#### Question 3

Do you agree with TRA's proposals regarding the withdrawal of Wholesale DSL as a regulated product, and in particular with the proposed safeguards? Please elaborate.

#### The March 2009 Study

67. Batelco is currently offering Bitstream, as well as Wholesale DSL, to OLOs. In the particular case of the Kingdom of Bahrain, the difference between Wholesale DSL and Bitstream is much less than in other countries as:
  - a) the level of investment required by OLOs for Bitstream is relatively low, because broadband traffic is delivered at a single aggregation point;
  - b) Bitstream does not enable significant product differentiation at the retail level compared to retail offers based on Wholesale DSL, since the same download speeds are available with the two products, and Wholesale DSL products provide the choice of several different thresholds (i.e. maximum amount of data that can be downloaded by end-users per month).
68. Having said that, TRA considers that Bitstream is a more suitable wholesale product to promote sustainable access-based competition for the long-term benefit of end-users. Bitstream is already available and has greater potential to allow OLOs to differentiate their retail offers from those of the incumbent. It does so because OLOs can have greater control over the quality parameters of their services compared to merely reselling the retail product of the incumbent operator. Even if the level of differentiation offered currently by Bitstream is limited compared to Wholesale DSL, TRA is of the view that Bitstream is preferable to pure resale as Bitstream can evolve.
69. TRA considers that after LLU and Bitstream are both established as viable wholesale products, the need for continued regulation of Wholesale DSL will fall away.
70. For these reasons, TRA believes that it is no longer necessary to maintain an access obligation on Batelco for Wholesale DSL, subject to appropriate safeguards.
71. Therefore, within 12 months from the date of the issuance of the Access Order,<sup>21</sup> TRA shall commence a study to determine whether the Bitstream service is "fit for purpose". Should TRA determine that the Bitstream service is fit for purpose, TRA shall remove the obligation on Batelco to provide Wholesale DSL no sooner than 6 months from the

<sup>21</sup> See TRA Access Order, Order 1 of 2009, (Reference MCD/09/09/65)

issuance of that determination. This determination may include specific provisions for the migration of end-users to an appropriate replacement service or other terms including but not limited to Bitstream or LLU.

### **Responses to the March 2009 Study**

72. Lightspeed is of the view that Wholesale DSL should remain a regulated product until LLU is effectively and successfully implemented.
73. Batelco agrees with TRA regarding the regulation of WDSL but believes that only Bitstream (and not LLU) is necessary before regulation of Wholesale DSL can be removed.
74. Batelco disagrees with the proposed steps for the removal of WDSL regulation and suggests that the study determining whether the Bitstream service is “fit for purpose” should be conducted within 6 months from the date of issuance of the Access Order and that, if TRA determines that Bitstream is fit for purpose, then TRA should remove the regulation of Wholesale DSL within 3 months.
75. Batelco believes that TRA’s safeguards are overly cautious and the associated timelines too long. This is due to the fact that, according to Batelco, Bitstream is a product that has a relatively short timeframe for take-up and efficient use, especially compared to LLU, which requires higher upfront capital charges. Batelco adds that the technical, operational and commercial arrangements for Bitstream allow competitors to enter the market more quickly and that the benefits from Bitstream start to flow through to the consumer almost immediately.

### **TRA analysis and conclusion**

76. In response to Lightspeed’s comment, TRA disagrees that the removal of regulation of Wholesale DSL should be justified by the positive results from the successful implementation of Full LLU. TRA is of the view that the main reason for removing regulation of the Wholesale DSL product should be that Bitstream is “fit for purpose” because Wholesale DSL is very similar to Bitstream in Bahrain, mainly due to the size of the country, while Wholesale DSL is very different from LLU. If the Bitstream product is “fit for purpose”, the Wholesale DSL will become less useful. If the LLU product is successfully implemented but the Bitstream product is not fit for purpose, then the Wholesale DSL product will still remain useful.
77. Regarding Batelco’s comment that only Bitstream (and not LLU) is necessary before regulation of Wholesale DSL can be removed, TRA has explained (see paragraphs 48 to 51 above) that LLU and Bitstream are complementary wholesale products required in order to promote competition.
78. With regards to Batelco’s proposition to conduct a study within 6 months from the date of issuance of the Access Order and to remove regulation of Wholesale DSL within 3 months after that, TRA believes that these timelines are too short. The current take-up of Bitstream is extremely low and there are only two OLOs purchasing the Bitstream product whereas six OLOs are purchasing Wholesale DSL services from Batelco, two of which are the same Batelco customers of Bitstream. It is also worth mentioning that the second Bitstream OLO has only taken up the service from Batelco very recently.
79. TRA believes that it is important to see the evolution of the current trend over a reasonable period of time. TRA is of the view that, if the study was conducted within 6 months, then the conclusions would very likely be that the Bitstream product is not “fit

for purpose”, notably because the number of Bitstream lines is extremely low. Also, TRA believes that, if the study determines that the Bitstream product is “fit for purpose”, 3 months will be too short for OLOs purchasing Wholesale DSL to migrate towards Bitstream because they will need time to understand the product, to buy international capacity and to migrate their customers.

80. Having considered the views of the respondents, TRA remains of the view that, with LLU and Bitstream in place, regulation of Wholesale DSL may no longer be necessary, subject to the following safeguards: within 12 months from the date of the issuance of the Access Order, TRA shall commence a study to determine whether the Bitstream service is ‘fit for purpose’. Should TRA determine that the Bitstream service is fit for purpose, TRA shall remove the obligation on Batelco to provide Wholesale DSL no sooner than 6 months from the issuance of that determination. That determination may also include specific provisions for the migration of end-users to an appropriate replacement service or other terms, including but not limited to, Bitstream or LLU.

## **4 Assessing whether it is no more than is appropriate and necessary to impose upon Batelco an obligation to provide LLU to address the market failure identified**

81. Batelco currently does not offer LLU. As per Article 3.7 of the Access Regulation, the imposition of LLU as a new access obligation requires TRA to assess whether such obligation is no more than is appropriate and necessary to address the market failure identified, namely that Batelco is dominant in the wholesale physical network infrastructure access market in the Kingdom of Bahrain. As per Article 3.7, in assessing whether the proposed access obligation will promote competition and the interest of users, TRA needs to consider:

- (a) the technical and economic viability of installing competing facilities, in light of the level and rate of market development;
- (b) the feasibility and efficiency of providing the form of access, particularly in light of the available capacity; and
- (c) TRA's duty to safeguard and encourage the long-term development of competition and the long-term interests of end-users.

### **4.1 The technical and economic viability of installing competing facilities to the existing local loop, in light of the level and rate of market development**

#### **Question 4**

Do you agree with TRA's opinion that, taking into account the technical and economic viability of installing competing facilities in light of the level and rate of market development, it is no more than appropriate and necessary to address the market failure identified to impose upon Batelco an obligation to provide LLU? Please elaborate.

#### **The March 2009 Study**

82. Relevant competing facilities in the context of LLU are local loops alternative to Batelco's copper local loop that can provide broadband services.
83. The local loop is the "last mile" of an operator's telecommunications network that connects the customer premises to the operator's core network (in which switching, routing and intelligent equipment are connected to each other). The local loop is "a highly capital-intensive business".<sup>22</sup>
84. The technical and economic viability of installing competing facilities needs to be considered for the loops that are included in the relevant market, i.e. the market for physical network infrastructure access, as defined in the Dominance Determination. In fact, following an extensive analysis, TRA has concluded in its Dominance Determination that wireless local loops are not part of the wholesale physical network infrastructure access market (i.e. the market which includes fixed loops) and hence cannot be strictly considered as "competing facilities".

<sup>22</sup> TRA, "Dominance in Wholesale Markets: a Consultation Issued by the Telecommunications Regulatory Authority on Dominance in Wholesale Markets", 27 October 2005, page 34.

85. Given the characteristics of wired local loops, TRA considers that the technical and economic viability of installing and deploying such competing facilities on a nationwide basis is highly unlikely in light of the level and rate of market development. In fact, building a wired local loop, be it based on copper or fibre, involves very substantial civil work costs and cable costs of a similar reach as Batelco's existing copper-based local loop does. The capital requirement, coupled with the sunk nature of the cost involved in deploying a wired local loop, and demand conditions make the duplication of wired local loops on a significant scale particularly challenging and highly unlikely on a commercial basis. Wired local loops, in some countries such as France, are qualified as "essential facilities", i.e. facilities which have very limited, if any, prospects of being duplicated and access to which is required in order to compete in related markets.<sup>23</sup>
86. In addition to sunk costs, economies of scale and scope constitute another considerable barrier to entry. Batelco benefits from significant economies of scale (or density) and economies of scope, as Batelco provides voice and Internet access services through its copper local loop. An operator building an alternative local loop would unlikely benefit from the same level of economies of scale and would have to offer the same suite of services to reach a similar level of economies of scope.
87. TRA also notes that the deployment of an alternative wired local loop would be particularly time-consuming.
88. Further, TRA is unaware of any OLO intending to deploy an alternative copper local loop and considers it highly unlikely in the relevant timeframe of this analysis.
89. For the reasons set out above and by appropriately pricing local loops TRA is of the view that imposing upon Batelco an obligation to provide LLU is unlikely to adversely impact potential investment in competing local loops in light of the level and rate of market development in the relevant timeframe of this analysis.
90. Overall, taking into account the technical and economic viability of installing competing facilities in light of the level and rate of market development, TRA considers that it is no more than appropriate and necessary to address the market failure identified to impose upon Batelco an obligation to provide LLU as:
  - a) Batelco's copper local loop is highly unlikely to be replicable by an alternative wired local loop in the relevant timeframe of the analysis;
  - b) By appropriately pricing local loops, imposing upon Batelco an obligation to provide LLU to OLOs is unlikely to have a negative impact on investment incentives in competing facilities.

---

<sup>23</sup> See Conseil de la Concurrence, Avis No 04-A-01 du 8 janvier 2004.

## Responses to the March 2009 Study

91. Lightspeed agrees with TRA and stresses that there are only two options to establish effective competition in the market: either by duplicating the infrastructure of the incumbent, which is not in line with international best practice and not economically efficient, or by using the network of the incumbent through LLU.
92. Batelco disagrees with TRA because Batelco considers that it is neither technically viable nor economically viable to mandate LLU.
93. Batelco argues that it is not technically viable to mandate LLU, an examination of the type of LLU being mandated, line quality and network coverage issues, specific site-by-site conditions, and circumstances that come to light as a result of full and thorough survey and assessment, as well as the development of an interference management plan.
94. Batelco also argues that LLU is not economically viable, taking into account the further upfront capital investment required by a new entrant compared to Bitstream (DSLAM, collocation facility, backhaul, upgrade and expansion of the network management systems, etc.) and because there is no sufficient demand for LLU (which prevents Batelco from recovering the costs of implementing LLU):
  - a) There is no evidence that operators in Bahrain would prefer LLU compared to Bitstream.
  - b) Batelco believes that only 10 to 15 Service Nodes would be served by LLU.
  - c) Batelco refers to the Singapore example, where LLU was mandated but there has been a minimal take-up of the service: *"There is little or no take up of these [interconnection-related] services - the existence of extensive facilities and services-based competition, which has resulted in telecommunications licensees either deploying and utilising their own infrastructure, or availing themselves of one of the various other wholesale services that is available in the market place".*<sup>24</sup> According to Batelco, LLU has distracted SingTel from other, more effective and efficient endeavours and investment in the telecommunications market.
  - d) Batelco refers to New Zealand, where LLU was not introduced in 2003 as the regulator was not convinced that there was sufficient demand for LLU. Batelco considers that the situation in Bahrain is similar to the one in New Zealand.
  - e) Batelco refers to the UK example, where, in 2000, over 40 companies expressed interest in LLU but, in 2002, only seven operators were actually providing or were attempting to provide services via LLU. This led the OECD to conclude at that time that: *"the policy of unbundling the local loop has failed, as yet, to generate the benefits expected"*.
  - f) Batelco refers to Ofcom statements that: *"We must apply regulation in ways that are relevant and proportionate to the prevailing and future circumstances that we face. This has to take into account the need for investment and competition." "It is important that the costs of introducing competition are proportionate, and are not exceeded by the benefits it brings."*<sup>25</sup>
  - g) Batelco submits that TRA has not adequately proven that there is demand for LLU. Batelco suggests that TRA undertakes a study in two years to determine whether

---

<sup>24</sup> SingTel, "Singapore Telecommunications Limited: Submission on the Second Triennial Review of the Code of Practice for Competition in the Provision of Telecommunications Services", 30 December 2008.

<sup>25</sup> Ofcom, "Delivering Super-fast Broadband in the UK: Promoting Investment and Competition", 3 March 2009.

LLU has become more economically feasible or whether Bitstream is still the most economically feasible option for Bahrain.

### **TRA analysis and conclusion**

95. TRA considers that Batelco has misinterpreted TRA's question pursuant to Article 3.7 of the Access Regulation. The question required as per Article 3.7 of the Access Regulation) is not whether LLU is technically and economically viable but whether installing competing facilities is technically and economically viable. This element of Article 3.7 of the Access Regulation seeks to assess the extent to which the facilities to be accessed can be or are replicated in the timeframe of the analysis, i.e. the extent to which it represents an enduring economic bottleneck to which access should be given in order to promote competition. Thus, TRA considers Batelco's points not to be relevant.
96. Notwithstanding this, based on international experience and having regards to the characteristics of Bahrain, TRA is of the view that, prima facie it is technically and economically viable to mandate LLU.
97. Having considered the views of the respondents, TRA remains of the view that, taking into account the technical and economic viability of installing competing facilities in light of the level and rate of market development, it is no more than appropriate and necessary to address the market failure identified to impose upon Batelco an obligation to provide LLU.

### **4.2 The feasibility and efficiency of providing LLU, particularly in light of the available capacity**

#### **Question 5**

Do you agree with TRA's opinion that, taking into account the feasibility and efficiency of providing the form of access, particularly in light of the available capacity, it is no more than appropriate and necessary to address the market failure identified to impose upon Batelco an obligation to provide LLU? Please elaborate.

### **The March 2009 Study**

#### *Feasibility of providing LLU*

98. International experience in numerous jurisdictions demonstrates that it is perfectly feasible to provide LLU. It is mandated in the vast majority of, if not all, OECD countries. An extensive benchmarking exercise of developed countries conducted by the New Zealand Commerce Commission in 2007 found that LLU was working in about 30 developed countries around the world.<sup>26</sup>

---

<sup>26</sup> See Commerce Commission, 2007, Draft Decision 609, Appendix D.

99. Further, as shown in the Figure 8 below for selected countries (large and small), the share of LLU lines among broadband lines in various European countries is now significant, standing at 24%, 28%, 33% and 35% respectively in Italy, the UK, Germany and France in July 2008. TRA notes also that in some smaller European countries, such as Cyprus and Slovenia, the populations of which are approximately 800,000 and 2,000,000 respectively (i.e. in line with the population of Bahrain), the number of LLU lines compared to the number of broadband lines is significant (15% and 17% respectively by mid-2008).<sup>27</sup>

**Figure 8 - Percentages of unbundled lines among broadband lines in selected EU countries, July 2008**

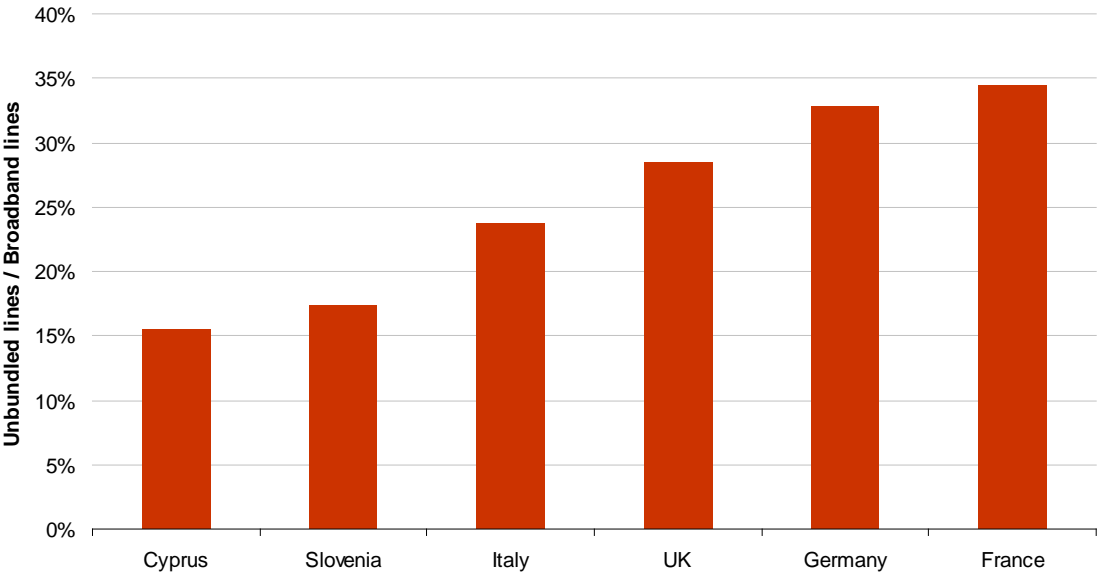

**Source: European Commission data, July 2008**

100. Furthermore, as the copper local loop offers a dedicated link for each end-user, this prevents the risk of insufficient capacity being available. In the context of this assessment, TRA has undertaken a review of a number of selected Service Nodes of Batelco and is of the view that there is *prima facie* no major issue in terms of available capacity for collocation. In the unlikely event of future capacity constraints, distant collocation could provide an alternative to collocation within the MDF sites of Batelco.

101. Therefore, having regard to the fact that LLU has been successfully implemented in both large and small countries all over the world by incumbent operators, TRA is of the view that providing LLU as a wholesale product is *prima facie* feasible by Batelco.

*Efficiency of providing LLU*

102. TRA notes that the demand in terms of broadband services in the Kingdom of Bahrain is high, as there are currently nearly 100,000 broadband customers for about 200,000 fixed lines. Also, the level of prices for broadband is currently high compared to other countries: for a 2 Mbps offer, Batelco’s broadband prices are among the highest

<sup>27</sup> Source: European Commission, “Broadband Access in the EU”, 2008.

compared to the EU15 countries, GCC countries (even though the comparison has recently improved compared to November 2008), and selected Arab countries and smaller states (see the price benchmarks included in Annex B: Domestic Benchmarks of Retail Broadband Offers and Teligen/Aregnet Price Benchmarking Studies).<sup>28</sup> TRA also notes that the download speeds currently offered are still relatively low and the threshold values are low compared to international standards (even though the comparison has recently improved compared to November 2008).<sup>29</sup>

103. In the Strategic and Retail Market Review (“SRMR”) Statement issued on 3 June 2008, TRA proposed a set of nine measures to promote further competition and the interests of consumers in the telecommunications sector in the Kingdom of Bahrain, among which was the introduction of LLU.<sup>30</sup>
104. Based upon the available international evidence on LLU, TRA considers that Bahrain will greatly benefit from the introduction of LLU. LLU can be expected to bring significant efficiency gains by: strengthening competition in broadband markets; facilitating the introduction of innovative and more diversified services; putting pressure on prices; fostering increases in available download speeds and thresholds. TRA is of the view that these benefits will outweigh *prima facie* the costs of implementing LLU. Overall, LLU will contribute to raising the performance of the domestic telecommunications sector and make it more in line with advanced countries.
105. Greater competition will give rise to:
- a) Productive efficiency gains: as in a more competitive environment, operators will have stronger incentives to become more efficient in the provision of their broadband services.
  - b) Allocative efficiency gains: as in a more competitive environment, end-users will enjoy lower prices. This in turn will lead to a higher penetration for broadband services, including higher download speeds and thresholds.
  - c) Dynamic efficiency gains: as a more competitive environment fosters innovation, and leads to an overall expansion in the broadband market.

### Conclusion

106. Overall, taking into account the feasibility and efficiency of providing the form of access, particularly in light of the available capacity, TRA considers that it is no more than appropriate and necessary to address the market failure identified to impose upon Batelco an obligation to provide LLU for the following reasons:
- a) Providing LLU as a wholesale product is *prima facie* feasible by Batelco as LLU has been implemented in significant number of large, as well as small, countries all over the world by incumbents.
  - b) As the copper local loop offers a dedicated link for each end-user, this prevents the risk of insufficient capacity.
  - c) Following a review of selected Service Nodes of Batelco, TRA is of the view that there is *prima facie* no major issue in terms of available capacity for collocation. In

---

<sup>28</sup> Teligen, “Telecoms Price Benchmarking for Arab Countries”, June 2008 and June 2009.

<sup>29</sup> Cf. Annex B: Domestic Benchmarks of Retail Broadband Offers.

<sup>30</sup> TRA, “Statement on the Strategic and Retail Market Review”, 3 June 2008, page 5.

the unlikely event of future capacity constraints, distant collocation could provide an alternative to collocation within the MDF sites of Batelco.

- d) LLU will provide significant efficiency net gains and will contribute to bringing the performance of the telecommunications sector in terms of broadband more in line with advanced countries.

### **Responses to the March 2009 Study**

- 107. Lightspeed agrees with TRA.
- 108. Batelco agrees with the fact that the provision of LLU is *prima facie* feasible but believes it is not efficient and that LLU should be mandated only if its benefits clearly exceed costs. In that context, Batelco refers to New Zealand, where the decision to regulate Bitstream instead of LLU was made after a complex cost benefit analysis for each service, showing that efficiency gains from Bitstream exceed those from LLU, with a consumer welfare effect (sum of allocative efficiency, productive efficiency and transfer effect) of \$170.8 million for introducing Bitstream and \$83.8 million for introducing LLU.<sup>31</sup> New Zealand decided that the benefit of providing LLU in addition to Bitstream would be much smaller and potentially negative.
- 109. Batelco asserts that the same results would be achieved in the specific case of the Kingdom of Bahrain and urges TRA to undertake a similar study (in which the expected efficiency gains are quantified). Considering that such a study would take time, Batelco suggests inferring, from the New Zealand study, that Bitstream is superior to LLU, and hence that only Bitstream should be mandated.
- 110. In addition, Batelco suggests that, after two years, TRA could undertake a full study to see whether LLU and Bitstream are appropriate.

### **TRA analysis and conclusion**

- 111. TRA understands that Batelco suggests TRA should undertake a full blown quantitative cost-benefit analysis ("CBA"), for LLU and Bitstream along the line of the approach followed by the Commerce Commission in New Zealand.<sup>32</sup>
- 112. TRA notes, firstly, that the legal framework in Bahrain does not require TRA to undertake an extensive quantitative CBA analysis but to answer the question as per Article 3.7 of the Access Regulation of whether, taking into account the feasibility and efficiency of providing the form of access, particularly in light of the available capacity, it is no more than appropriate and necessary to address the market failure identified to impose upon Batelco an obligation to provide LLU.
- 113. In the March 2009 Study, TRA compared the relative advantages of both LLU and Bitstream and analysed their complementarities. TRA also outlined the expected economic benefits of introducing LLU in terms of efficiency gains. Costs to be

---

<sup>31</sup> New Zealand Commerce Commission, "Telecommunications Act 2001: Section 64 Review and Schedule 3 Investigation into Unbundling the Local Loop Network and the Fixed Public Data Network", October 2003.

<sup>32</sup> New Zealand Commerce Commission, "Telecommunications Act 2001: Section 64 Review and Schedule 3 Investigation into Unbundling the Local Loop Network and the Fixed Public Data Network", October 2003.

considered include primarily the implementation cost of LLU.<sup>33</sup> Having regards to expected benefits and cost and taking into account the feasibility and efficiency of providing the form of access, TRA concluded that LLU should be introduced.

114. With respect to a “full quantitative” assessment, TRA agrees with Batelco that such an analysis is very “complex” and is very sensitive to the necessary assumptions that have to be made. CBA models have to be calibrated to the market being analysed. TRA considers it would be inappropriate to infer from the results of the New Zealand Commerce Commission Study conducted in 2003 that LLU should not be mandated, especially given that LLU has subsequently been introduced in New Zealand to overcome the limitations of an access regime based only on bitstream.
115. TRA observes, furthermore, that very few countries have done such a “full quantitative” CBA for LLU and Bitstream. TRA is aware, for example, of the New Zealand case in 2003 (quoted by Batelco) and of the UK case in 1999.<sup>34</sup>
116. TRA also notes that in those two countries where such a “full quantitative” CBA was completed:
  - a) The benefits of LLU provided in addition to Bitstream are positive,<sup>35</sup>
  - b) LLU has been mandated, even if it was mandated after Bitstream in New Zealand once New Zealand assessed that Bitstream alone failed to produce appropriate outcomes.
117. Nevertheless, the following high level analysis gives an order of magnitude of the potential gains of allocative efficiency. LLU can be expected to lead to lower prices of broadband which in turn will stimulate demand. Taking a reasonable assumption that LLU will lead to a decrease in prices of BD4 on average and a simulation of demand of 4% per annum, the net present value of consumer surplus gains over a five year period at a discount rate of 5% would be approximately BD18 million<sup>36</sup>. This analysis is conservative. It ignores other efficiency gains, such as increase in consumers’ willingness to pay, expected decline in cost due to the strengthening of competitive pressures as well as dynamic efficiency gains (e.g. new services).
118. Having considered the views of the respondents, TRA remains of the view that, taking into account the feasibility and efficiency of providing the form of access, particularly in light of the available capacity, it is no more than appropriate and necessary to address the market failure identified to impose upon Batelco an obligation to provide LLU.

---

<sup>33</sup> According to the study quoted by Batelco, the cost of implementing LLU for a small country like Bahrain can be expected to be around euro 500,000. See Ovum and Indepen, “Applying the EU framework in Microstates”, June 2005.

<sup>34</sup> Oftel, “Access to Bandwidth: Delivering Competition for the Information Age – Annex D”, 1999.

<sup>35</sup> The benefits of LLU as estimated for the UK market would stand between £120m and £440m, depending on a range of assumptions and the expected timing of competitive alternatives to copper loop technology.

<sup>36</sup> The consumer surplus is calculated for the year one as follows: [100,000 (number of subscribers at the starting point) x 4 (price reduction) x 12 (number of months)] + [4,000 (number of subscribers at the end of year one – number of subscribers at the beginning) x 4 (price reduction) x 12 (number of months) / 2 (to calculate the area of the triangle)]. If a total welfare standard is adopted instead (i.e. excluding wealth transfers from consumers to producers), the estimated gains are approximately BD0.9 million.

### 4.3 TRA's duty to safeguard and encourage the long-term development of competition and the long-term interests of end-users

#### Question 6

Do you agree with TRA's opinion that, taking into account TRA's duty to safeguard and encourage the long-term development of competition and the long-term interests of end-users, it is no more than appropriate and necessary to address the market failure identified to impose upon Batelco an obligation to provide LLU? Please elaborate.

#### The March 2009 Study

##### *Long-term development of competition*

119. As indicated in the SRMR Statement, issued on 3 June 2008, TRA considers that LLU makes the introduction of competition into associated broadband retail markets easier, as it removes one of the major barriers to entry, which is the installation of a full-fledged alternative local loop.

120. As exemplified by experience overseas,<sup>37</sup> LLU will encourage competition. The advent of LLU-based services will incentivise operators to compete over quality and prices. The emergence of alternative DSL technologies using LLU will also continue to transform the number and type of services that can be delivered via the copper local loop to end-users, thereby generating innovation and bringing dynamic efficiency gains.

121. These competitive benefits of LLU have been articulated by regulators, as illustrated by the following quotes from ComReg (the Irish regulator) and ARCEP (the French regulator):

*"The direct benefit of having a LLU product is that OLOs are more able to compete in the retail broadband market, and that this then has a positive impact on consumer services and on the prices for those services".<sup>38</sup>*

*"Voice over broadband and television were primarily developed by OLOs. It is on those services that ISPs can more easily differentiate themselves in terms of quality of services provided or features included in the 'box'. Unbundling is therefore a driver of innovation competition, and market development".<sup>39</sup>*

122. Further, it is interesting to note that in some European countries triple play services have first been offered by LLU operators: Free in France, Fastweb in Italy and Magnet in Ireland.

123. However TRA is aware that there are competing arguments according to which LLU may discourage infrastructure-based competition, and in particular in competing platforms, be it wired or wireless. As explained above, TRA considers that, provided

<sup>37</sup> See e.g. "EC Progress Report on the Single European Electronic Communications Market 2007".

<sup>38</sup> ComReg, "Wholesale Unbundled Access Market Analysis", June 2008.

<sup>39</sup> ARCEP, "Wholesale Market Analysis", 2008.

that LLU is appropriately priced, it is unlikely to impact negatively on investment incentives in competing facilities in Bahrain.

124. TRA notes that LLU is associated with investment in infrastructure, as OLOs will need to deploy a core network to reach Service Nodes (of MDFs) of the incumbent and install their own active exchange equipment (including but not limited to DSLAMs/MSANs). LLU will therefore contribute to strengthening the sustainability of competition in related retail markets, as it limits the dependence of OLOs on the incumbent. Some OLOs may use LLU as their sole means of reaching the retail market while others may use LLU products to supplement their own infrastructure.
125. TRA notes, furthermore, that in other jurisdictions LLU is actually becoming a stepping stone toward the deployment of alternative local loops based on fibres (e.g. OLOs such as Fastweb in Italy and Free in France). There are high barriers to entry associated with the deployment of an alternative wired local loop, as it is time- and capital-intensive. In this context, LLU can help secure the critical mass of customers at local level that may make the investment in FTTH/FTTB more attractive.

#### *Long-term interests of end-users*

126. TRA expects LLU to bring long-term benefits to end-users in terms of lower prices, faster download speeds and higher threshold values, as well as additional retail services such as video on demand, television, music on demand, High Definition voice services. Better broadband services can be expected to encourage the use of broadband and make applications such as e-government and e-commerce applications more attractive.
127. In its first consultation on its Strategic and Retail Market Review<sup>40</sup> TRA observed that, despite a relatively high penetration rate compared to other GCC countries, there is a *“lack of competitive broadband services beyond the speed of 2 Mbps and the absence of ‘unlimited’ broadband offerings for residential users”*.
128. Despite the launch of NFWS-based offers and the availability of Wholesale DSL and Bitstream, Bahrain is still not performing satisfactorily by international benchmarks.
129. TRA acknowledges that the launch of NFWS-based broadband offers has increased the level of competition for the provision of broadband services, with more aggressive pricing. Batelco’s prices for 2 Mbps are, nevertheless, among the highest compared to incumbents’ offers in other countries such as the EU15 countries, GCC countries, selected Arab countries and smaller states (see benchmarks contained in Annex B: Domestic Benchmarks of Retail Broadband Offers and the Teligen/Aregnet Price Benchmarking Study of Arab Countries).<sup>41</sup> TRA is of the view that LLU will provide additional competitive pressure on prices in Bahrain.
130. TRA notes also that the download speeds offered by NFWS operators are relatively limited and the threshold values (maximum number of Mbps that can be downloaded per user and per month) are low.<sup>42</sup> TRA is of the view that LLU will provide additional competitive pressure on download speeds and threshold values in Bahrain.

---

<sup>40</sup> TRA, “2007, Strategic and Retail Market Review – Consultation”, 27 August 2007.

<sup>41</sup> Teligen, “Telecoms Price Benchmarking for Arab Countries”, June 2008 and June 2009.

<sup>42</sup> Cf. Annex B: Domestic Benchmarks of Retail Broadband Offers.

131. More generally, TRA believes that the views expressed by the OECD on the potential benefits of LLU for end-users are entirely applicable for Bahrain:<sup>43</sup>

*“The majority of countries consider that LLU has the potential to enhance local competition and assist in the development of competition for broadband services as well as in its diffusion. From this perspective, implementation of LLU is expected to benefit consumers by reducing not only local telephony but also broadband internet access costs and accelerating the supply of new services.”*

### Conclusions

132. Overall, taking into account TRA's duty to safeguard and encourage the long-term development of competition and the long-term interests of end-users, TRA considers that it is no more than appropriate and necessary to address the market failure identified to impose upon Batelco an obligation to provide LLU for the following reasons:
- a) LLU, when appropriately priced, is unlikely to negatively impact investment incentives in competing facilities,
  - b) LLU will further strengthen competition for the long-term benefits of end-users, and hence LLU is fully consistent with TRA's duty to encourage competition and the interests of end-users,
  - c) LLU will contribute to closing the gap between the prices and types of broadband services available in Bahrain and those available in more advanced countries.

### Responses to the March 2009 Study

133. Lightspeed agrees with TRA.
134. Batelco disagrees with TRA because Batelco considers that mandating LLU will encourage neither the long-term development of competition nor the long-term interests of users.
135. Batelco considers that mandating LLU will not encourage the long-term development of competition because LLU is increasingly becoming an outdated solution in the legacy telecommunications environment. Batelco adds that all of the benefits of LLU detailed by TRA in paragraphs 59 to 65 of the March 2009 Study apply also or apply more to Bitstream. In particular, Batelco states that LLU may encourage competition but so will bitstream.
136. Batelco refers to figures from European markets showing that Bitstream has taken up exponentially in early years:
- a) 40% of broadband retail services provided by alternative operators were based on Bitstream in 2003, while only 15% in 2002 were (which corresponds to respectively around 2 million customers and 400,000 Bitstream customers);<sup>44</sup>
  - b) In 2003 the share of Bitstream services among LLU and Bitstream customers was far greater than LLU;<sup>45</sup>

---

<sup>43</sup> OECD, “Working Party on Telecommunication and Information Services Policies – Developments in Local Loop Unbundling”, 10 September 2003.

<sup>44</sup> Source: pointtopic.com.

<sup>45</sup> Source: ECTA.

- c) The number of Bitstream customers increased between the first quarter of 2007 and the third quarter of 2008 in Belgium, Denmark, France, Hungary, Ireland, Italy, Lithuania, Malta, Poland, Slovenia and Spain. Overall, it increased from 3.2 million to 4.9 million.<sup>46</sup>
137. Referring to a WIK-Consult report made for ComReg in 2007,<sup>47</sup> Batelco notes that, while in some EU countries triple play services have first been offered by LLU operators, many consider that the economic LLU footprint of these OLOs may not reach far enough to sustain competition through triple play packages over wider geographic areas.
138. Batelco believes that it is not true to state that “*some OLOs may use LLU as their sole means of reaching the retail market*”<sup>48</sup> and believes that Bitstream is far superior to LLU in residential markets and refers to the ERG stating: “*the provision of Bitstream access is essential to the development of competition in the wholesale broadband access market as well as in the retail services market [and] NRAs should mandate this access product.*”<sup>49</sup> Batelco adds that Bitstream is cheaper to implement than LLU and will allow for greater competition on price and thereby lead to enhanced competition for Bahrainis in the long term.
139. Batelco considers also that LLU will discourage infrastructure-based competition. Batelco is of the view that, while TRA believes that an appropriately priced LLU product can mitigate the risk of discouraging infrastructure-based competition, the example of Bitstream pricing in Bahrain tends to show that the prospects for an “appropriately priced” LLU product is low. Batelco refers to the cases of the USA, the UK and Canada, where LLU has been introduced but infrastructure-based competition has not increased. Batelco states that TRA should recognise that there is a trade-off between imposing a further remedy in respect of Batelco’s fixed network and the development of competition on alternative network platforms.
140. Batelco considers that mandating LLU will not be in the long-term interest of end-users because LLU is increasingly becoming an outdated solution in a legacy telecommunications environment and also because LLU will benefit only a limited category of locations and customer segments in Bahrain.
141. Batelco adds that, in order to develop broadband, which is an important component of an information society,<sup>50</sup> TRA should examine what consumers want in terms of technology and services. Batelco exemplifies this statement with the success of NFWS operators, which shows, according to Batelco, that Bahrainis have an appetite for alternative technologies and services.
142. Batelco submits that Bitstream will deliver end-users with many of the same benefits as LLU: lower prices, higher speeds and higher thresholds; and that these benefits will be achieved at lower implementation costs.

---

<sup>46</sup> Source: ECTA.

<sup>47</sup> WIK-Consult, “Next Generation Bitstream Access: Study for the Commission for Communications Regulation”, 19 November 2007.

<sup>48</sup> See TRA, “Study on the Regulation of Wholesale Broadband Markets”, 26 March 2009, page 22.

<sup>49</sup> Bitstream Access, ERG Consultation Document, 14 July 2003.

<sup>50</sup> Batelco quotes here the WSIS Declaration of Principles (“World Summit on the Information Society, Declaration of Principles Building the Information Society: A Global Challenge in the New Millennium”, 12 December 2003) and the objectives of the National Telecommunications Plan.

## TRA analysis and conclusion

### *Long-term development of competition*

143. In response to Batelco's view that mandating LLU will not encourage the long-term development of competition, TRA disagrees with Batelco's statement that all of the benefits of LLU detailed by TRA in paragraphs 59 to 65 of the March 2009 Study apply also or more to Bitstream. For example:
- a) Bitstream is less of a stepping stone than LLU is towards the deployment of competing facilities (paragraph 65 of the March 2009 Study).
  - b) Bitstream does not offer the same level of independence from the incumbent to OLOs compared to LLU (paragraph 64 of the March 2009 Study).
  - c) Bitstream does not offer more room for competition compared to LLU (paragraph 60 of the March 2009 Study), in terms of product differentiation for example.
144. Regarding Batelco's figures from the European markets showing that Bitstream has taken up exponentially in early years, TRA cannot reconcile the number provided by Batelco. On the contrary, based on available information from the European Commission, TRA notes that, until 2005, Bitstream and LLU had a similar growth (in terms of number of lines) and that from 2005, the growth in the number of Bitstream lines has slowed down compared to the growth of LLU lines. In January 2009, there were 4.5 more LLU lines per every Bitstream line in EU15. This supports the view that LLU is also a mass market product and that both LLU and Bitstream are required contrary to Batelco's arguments.
145. Regarding Batelco's reference to the WIK-Consult report for ComReg, TRA highlights that the statement is primarily related to the Irish case. In fact, WIK-Consult states that triple play offers at the international level are based on LLU rather than Bitstream: *"today international OAOs are primarily implementing their triple play services on the basis of unbundled loops rather than Bitstream"*.<sup>51</sup>
146. Contrary to Batelco's statement, TRA is of the view that the LLU product can address the mass market (see Figure 7 and paragraph 62). TRA also believes that LLU enables greater competition in prices than Bitstream because LLU offers more room for manoeuvre for OLOs not only from a technical point of view but also from a pricing point view because OLOs are renting a smaller part of the incumbent's infrastructure with LLU compared to Bitstream. Furthermore, LLU allows greater non-price competition in terms of product differentiation and innovation.
147. In response to Batelco's comment that LLU will discourage infrastructure-based competition, TRA remains of the view that it is to a large extent a pricing issue, as explained in the March 2009 Study. Also, TRA is of the view that the trade-off between imposing a further remedy in respect to Batelco's fixed network and the development of competition on alternative network platforms has been considered by TRA, especially through the definition of relevant markets in the Dominance Determination and above in this study. TRA also believes that the deployment of an alternative infrastructure in the Kingdom of Bahrain with at least the same capabilities as Batelco's access network is not economically feasible in the medium term and that LLU can be used as a stepping

---

<sup>51</sup> WIK-Consult, "Next Generation Bitstream Access: Study for the Commission for Communications Regulation", 19 November 2007, page 11.

stone towards the building of such alternative infrastructure(s), as the example of other jurisdictions shows (see paragraph 57). Finally, TRA believes that Batelco's references to the UK, the USA and Canada are outdated as they date back to November 2004 and are based on data up to 2002 or 2003. In particular, TRA observes that, despite the successful implementation of LLU in the UK, there are plans to deploy alternative infrastructures (see paragraph 57) and there is strong alternative infrastructure competition in the UK: in January 2009, 21% of broadband lines in UK were not provided on the basis of DSL technology.<sup>52</sup>

#### *Long-term interests of end-users*

148. Regarding Batelco's view that mandating LLU will not be in the long-term interest of end-users, TRA disagrees with Batelco for the following reasons:

- a) TRA believes that LLU will benefit not only a limited category of locations and customer segments in Bahrain. Even though TRA is aware that it is difficult to achieve a nation-wide coverage with LLU, TRA observes that, if OLOs unbundle ten to fifteen Service Nodes, they will cover between 50% and 70% of the population. TRA is of the view that LLU can be a mass-market product as explained above. While the footprint of LLU may be less than the whole country, TRA anticipates that retail offers from unbundlers will provide competitive pressures beyond their footprint unless Batelco decides to offer geographically differentiated services which is highly unlikely given the size of the Kingdom of Bahrain.
- b) TRA believes that it has considered what consumers want in terms of services and technology. This has been done first in the "Strategic and Retail Market Review" public consultation of 27 August 2007, in the "Significant Market Power Designation in Certain Relevant Retail Markets" of 3 June 2008, and through the extensive consultation on LLU. It appears that end-users' preference for higher download speeds, higher reliability, lower prices, and greater download allowances are broadly homogeneous across the world for countries of similar income per capita.
- c) TRA believes that LLU can deliver greater benefits to end-users than bitstream. For instance LLU allows the introduction of new services significantly different from those provided by the incumbent (for example, IPTV, video on demand, voice over broadband, etc.), higher download speeds or higher threshold values because OLOs can choose the type of DSL technology they want to deploy (e.g. ADSL2+ allows the provision of download speeds up to 20 Mbps) and because OLOs can manage their own backhaul and international capacity.

#### *Conclusion*

149. Having considered the views of the respondents, TRA remains of the view that, taking into account TRA's duty to safeguard and encourage the long-term development of competition and the long-term interests of end-users, it is no more than appropriate and necessary to address the market failure identified to impose upon Batelco an obligation to provide LLU.

## **4.4 Overall conclusion**

---

<sup>52</sup> Source: "Commission Staff Working Document, Annex to the Communication from the Commission to the European Parliament, the Council, the European Economic and Social Committee and the Committee of the Regions Progress Report on the Single European Electronic Communications Market 2008 (14th report)" {COM(2009) 140 final} – page 67.

### Question 7

Do you agree with TRA's overall conclusion that it is no more than appropriate and necessary to address the market failure identified to impose upon Batelco an obligation to provide LLU? Please elaborate.

### The March 2009 Study

150. For the reasons set out above, TRA considers that it is no more than appropriate and necessary to address the market failure identified to impose upon Batelco an obligation to provide LLU.
151. The details of the approach for the implementation of LLU are presented in a separate report.<sup>53</sup>

### Responses to the March 2009 Study

152. Lightspeed agrees with TRA.
153. Batelco disagrees with TRA for the reasons below:
- a) Any regulatory response needs to be proportionate. Batelco refers to Ofcom, which considered that it is important that the costs of introducing competition are proportionate and not exceeded by the benefits it brings.
  - b) TRA has not proven that there is adequate evidence of demand for LLU, while Batelco is expected to incur substantial upfront capital and operating costs.
  - c) Other countries that have recently considered LLU and Bitstream have approached regulation differently from those that regulated it 20 years ago and initially regulated Bitstream access only. According to Batelco, these different approaches reflect the shifting landscape towards an NGN environment. Batelco refers here to the following countries:
    - (i) In Malaysia, where regulated services are placed on the Access List, the Minister decided that only Bitstream would apply from 1 July 2005 and that other services (LLU, Sub-Loop Unbundling) would come into force at a later stage. In 2008-2009, the Access List was reviewed, but no change was made. Batelco reminds that, in the meantime, between 2004 and 2008, the number of Internet subscribers increased by 54% and the number of ISPs reached thirteen in 2008.
    - (ii) In Jordan, the shift from traditional legacy networks to NGNs was considered, and only cost-based Bitstream was initially mandated in 2005. In 2008 LLU was mandated in addition to Bitstream, and the TRC stated: "over the last 3 years many of the difficulties associated with the roll-out of LLU that were

<sup>53</sup> See Annex B to the Access Order, "Implementation Report for Local Loop Unbundling (LLU) in the Kingdom of Bahrain", September 2009.

experienced in countries with regulation that required its introduction have largely been overcome".<sup>54</sup> Batelco considers that the case of Jordan is relevant to Bahrain because the timetable in Jordan (LLU mandated three years after Bitstream, plus two years for LLU implementation) corresponds to what Batelco is requesting (a minimum of five years). Batelco also notes that it has made many improvements to the Bitstream product (relaxed forecasting requirements, more orders per batch, Inet helpdesk, etc.). Batelco submits that the Bitstream product that it supplies is provided over NGN, which makes the Bitstream product in Bahrain [•] to that in Jordan.

- (iii) In New Zealand, in 2003, the Commerce Commission decided to mandate Bitstream and not LLU. A cost-benefit analysis consisting of determining the net welfare gains for each regulatory product was conducted. Batelco notes that, five years later, in late 2007, the Commission decided to mandate LLU as well, which would take two years to be implemented according to the Ministry of Economic Development. Batelco submits that this change was made in response to low broadband uptake, which was due to the free local calling that reduces the difference between dial-up and broadband services. Batelco notes that, despite LLU launch, New Zealand sits in 19th position in the OECD ranking for broadband take-up.
- (iv) In the USA, the FCC decided to abolish LLU and Bitstream in 2003. According to Batelco, the FCC felt that it could no longer mandate LLU after having taken into account the deployment of alternative facilities, which Batelco states that TRA should do.
- (v) Batelco refers to a study by J. Hausman and G. Sidak<sup>55</sup> showing that LLU has not achieved its intended effect in terms of lower retail prices, ladder of investment and alternative infrastructure competition in the USA, in the UK and in Canada.

However, Batelco adds that the landscape in 2011 will be very different from 2009 and very different from the analysis undertaken in these countries.

- d) Batelco considers that Bitstream will be suitable for the interim period: it will be needed before broadband and NGN environments are fully developed. Batelco therefore proposes that only Bitstream should be regulated for the next two years and then an assessment should be undertaken to determine whether LLU should also be mandated. Batelco submits that:
  - (i) LLU is inappropriate and unnecessary because broadband, NGN and broadband competition (Batelco has a [•] market share in April 2009) are developing in Bahrain. Batelco emphasises that it stated, in the answer to the Strategic Review consultation: "there is a need to re-evaluate priorities in the next phase covered by the Strategic Review and beyond by boosting investment incentives for both the incumbent and new entrants prepared to roll out facilities and not, as the LECG paper suggests, create conditions where the sector 'finds itself in a DSL cul-de-sac'".

---

<sup>54</sup> TRC, "Notice Requesting Comments on the Implementation of Local Loop Unbundling, Collocation and Infrastructure Sharing in Jordan", 2008.

<sup>55</sup> Hausman J., & Sidak G., "Did Mandatory Unbundling Achieve its Purpose? Empirical Evidence from Five Countries", *Journal of Competition Law and Economics* 1(1), 173-245.

- (ii) Batelco adds that many initiatives are taking place (review of non-price terms of the reference offer, proposal to introduce MPLS, dark fibre, international facilities access products, proposal to revise carrier pre-selection and introduce carrier selection, operational procedures of the Telecommunications Technical Office, issue of a draft RAO order on 31 March 2009) and these have not been assessed in TRA's study. Assessing them would enable the conclusion that Bitstream is a proportionate and reasonable balance between costs versus benefits to provide access.
- e) LLU is becoming an increasingly outdated remedy for an old regulatory environment that is no longer appropriate or necessary and is an inappropriate remedy in an NGN world, as well as the investment ladder theory:
- (i) Batelco explains that TRA should implement only regulations that are strictly necessary in preparation for a NGN environment and not for a PSTN environment, especially as Batelco has completed recently the deployment of its NGN core network. Batelco adds that, while regulators are rolling back regulation of PSTN networks, they are now implementing regulations related to NGN. Batelco explains that LLU was implemented ten to fifteen years ago in many countries (1995 for Hong Kong; 1996 for the USA and Germany; 1997 for Canada, Japan, the Netherlands and Finland; 1998 for Australia, etc.), but that today, since the telecommunications market has developed and since the primacy of PSTN networks has been eroded, LLU is not suitable in an NGN environment. As a consequence, Batelco is of the view that TRA should not copy what has been done elsewhere (such as in the European Union) without examining the Bahraini context.
- (iii) Batelco explains that, from a technical point of view, Full LLU is envisaged at the MDF with PSTN architecture but that, with an NGA architecture (going up to the kerb or to the street cabinet), MDFs are not necessary anymore. This implies that there would be stranded assets for LLU investors and the migration from LLU to fibre would be weakened since LLU cost of acquisition would be unsustainable.
- (iv) Batelco quotes the OECD and the economist R. Nicholls:
- “The development of fibre networks requires that those regulators that have mandated local loop unbundling (LLU) should assess the economic and technical feasibility of continuing LLU policies in their country, taking into account investment plans of the incumbent, the presence of alternative network infrastructures, and the characteristics of particular markets, amongst other things, in order to begin to determine the best regulatory framework to ensure effective competition.”<sup>56</sup>*
- “the regulatory approach that applies to the legacy, copper-based, circuit-switched world is not applicable in the NGN environment... attempting to map the old regulatory world onto the new technology is an inappropriate response... the upstream market for applications and services can thrive as long as there is workable competition in the NGN access network and that it is at this level where a regulatory intervention is appropriate, if intervention is required at all.”<sup>57</sup>*

<sup>56</sup> OECD, “Working Party on Communication Infrastructure and Services Policy, Convergence and Next Generation Networks”, 29 April 2008.

<sup>57</sup> Nicholls R., “Pedestrian Crossing and Superhighway Robbery: Sources of Market Power in Broadband”, July 2008.

*“There is a significant risk that using existing regulatory models will hamper the development of a market for applications and services which are delivered using broadband. That is, there is a risk of regulatory intervention before any market is created in which there may be market power.”*

*“This means that some regulatory assumptions have to be unlearned. Whereas ULL is an important element of access network competition in the legacy circuit-switched world, it is not clear that such unbundling has any application in an NGN or in the approach to its regulation.”<sup>58</sup>*

- (v) Batelco submits that it has not yet announced plans for investing in NGN technologies and requests TRA to provide more certainty concerning the regulatory treatment of NGN technologies. Batelco is of the view that the introduction of LLU will add more uncertainty and will constrain the development of NGN in Bahrain.
- f) Batelco considers that Bitstream is superior to LLU as it:
- (i) has strong growth in countries where it has been introduced;
  - (ii) is superior in residential markets. Batelco refers here to the ERG statement that *“the provision of Bitstream access is essential to the development of competition in the wholesale broadband access market as well as in the retail services market [and] NRAs should mandate this access product”*,<sup>59</sup> and to the observation that 86% of wholesale lines in Australia and 99.3% in the UK are Bitstream lines, and to an FCC statement that the FCC is not aware of any new entrant who uses LLU to serve mass-market customers;
  - (iii) has a faster market entry time due to the fact that the technical, commercial and operational arrangements are more complex, extensive and controversial for LLU compared to Bitstream. Batelco submits that it took three years for LLU to be implemented in the UK and one year in Australia;
  - (iv) has lower upfront costs. For LLU, upfront costs are the MSANs, the collocation facilities, the backhaul, the upgrade of the network management system, the operation and network management functions but also the technical expertise. Batelco submits that, with LLU, competitors will invest in outdated technology, which will not be the case with Bitstream only. Also, for Batelco, since mass-market customers have lower revenues, the risk associated with LLU is higher than for Bitstream. Batelco quotes the ERG, stating that *“The economic differences between the two forms of access [i.e. LLU and Bitstream] may turn out more clearly, i.e. they may fit as different input products for different business models or for different phases of market entry. Bitstream access may be called a ‘low-cost option’ as less investment is required, but new entrants can nevertheless use their networks (without having to roll-out to the local MDFs as is the case for unbundled access). With Bitstream access, new entrants participate in the economies of scale (e.g. they use the DSLAM installed by the incumbent) thus leveraging off the economies of scale of the incumbent”*;<sup>60</sup>
  - (v) has significantly lower churn-associated costs: LLU requires the incumbent to remove and install jumpers manually at the MDF, while Bitstream provisioning can be done electronically;

---

<sup>58</sup> Nicholls R., “Pedestrian Crossing and Superhighway Robbery: Sources of Market Power in Broadband”, July 2008.

<sup>59</sup> ERG Consultation Document, “Bitstream Access”, 14 July 2003.

<sup>60</sup> ERG Consultation Document, “Bitstream Access”, 14 July 2003.

- (vi) has lower service-provisioning delays: Batelco explains that the LLU reassignment process is mainly manual and constrained by the staff that the incumbent can make available. Batelco refers to examples in Hong Kong, Australia or the USA, where the number of LLU orders is limited to 25 to 100 per exchange and per day. Batelco adds that US operators often report that more than half of all requests take more than seven days while US rules require it to be lower than seven days. According to Batelco, these physical constraints make LLU unsuitable, and Batelco exemplifies this with FCC statements about “hot cuts”.<sup>61</sup> Referring to the FCC, Batelco adds that the churn is higher in the mass market, which makes LLU more risky due to the higher associated upfront/non-recurring fees. These non-recurring fees may never be recovered if customers are churning rapidly;
- (vii) is more suitable in smaller countries. Batelco submits that TRA should not copy “macro-state” regulation like the European Union regulation. Here, Batelco makes extensive reference to a joint Ovum-Indepen paper (“Applying the EU Regulatory Framework in ‘Microstates’”). It is superior in difficult economic times. In particular, Batelco quotes the ERG, saying that *“Bitstream access might be the more appropriate access product in times of dry capital markets. The change of the financial market climate makes funding for new operators much more difficult.”*<sup>62</sup>

### TRA analysis and conclusion

154. In response to Batelco’s point (a), TRA is of the view that mandating LLU is proportionate. TRA is of the view that undertaking such a study as per Article 3.7 of the Access Regulation is precisely for the purpose of ensuring that mandating LLU is proportionate. In this study TRA has analysed available evidence and considered whether LLU is no more than appropriate and necessary to address the market failure identified by TRA in accordance with Article 3.7 of the Access Regulation.
155. Regarding Batelco’s point (b), TRA has established that there is sufficient demand for LLU by conducting interviews with OLOs in November 2008 and through the March 2009 Consultation process. Answers to this Consultation have shown that there are at least three OLOs interested in LLU. TRA will allow Batelco to recover the efficiently incurred implementation cost of LLU in a competitively neutral manner.
156. Regarding Batelco’s point (c), TRA is of the view that the approach it is proposing is consistent with the approach in countries that have recently considered LLU and Bitstream, such as New Zealand, Cyprus, Slovenia and Jordan. In particular, as explained in paragraphs 58 and 59 and in Annex C: LLU and Bitstream chronology in some smaller countries, TRA is of the view that the period of time between Bitstream being mandated and LLU being mandated is similar in the Kingdom of Bahrain as it is in Jordan and in New Zealand.
157. TRA concurs with Jordan TRC’s statement quoted by Batelco that *“over the last 3 years many of the difficulties associated with the roll-out of LLU that were experienced in countries with regulation that required its introduction have largely been overcome”*.<sup>63</sup>

---

<sup>61</sup> See FCC Report, “Triennial Review Order: Report and Order and Order on Remand and Further Notice of Proposed Rulemaking, in the Matter of Review of Section 251 Unbundling Obligations of Incumbent Local Exchange Carriers”, 21 August 2003.

<sup>62</sup> ERG Consultation Document, “Bitstream Access”, 14 July 2003.

<sup>63</sup> TRC, “Notice Requesting Comments on the Implementation of Local Loop Unbundling, Collocation and Infrastructure Sharing in Jordan”, 2008, page 7.

TRA believes that Batelco's statement that the Bitstream product in Bahrain is superior to that in Jordan is not clear, especially when looking at the recent evolution of the number of Bitstream lines in Bahrain.

158. LLU was introduced in New Zealand to remedy the disappointing performance of the access regime in which only bitstream was regulated. With the introduction of LLU, penetration has increased, broadband speeds have increased dramatically and prices have dropped. The experience of New Zealand, and in particular the recognition of the limitations of bitstream and its complementarities with LLU, are very relevant to the Kingdom of Bahrain.
159. In response to Batelco's reference to the FCC, which no longer mandate LLU and Bitstream since 2003 (although it is still widely available and used) and which felt that it could no longer mandate LLU after having taken into account the deployment of alternative facilities, TRA notes that its analysis has taken into account the deployment of alternative infrastructures but has reached different conclusions due to the specific context of the Kingdom of Bahrain.
160. Regarding Batelco's reference to the study by J. Hausman and G. Sidak (2004), which looks at the impact of LLU in the USA, the UK, Canada, New Zealand and Germany, TRA notes that it is based on data going back to 2002 and 2003, at a time when LLU was not fully effective and its full impact had yet to be felt. Considering the achievements of LLU in the UK and Germany (see paragraph 57) as well as in other countries since then and given the fact that LLU has been launched recently in New Zealand and is still widely used in the USA, TRA believes that the findings of that study are not relevant for the purpose of this Study.<sup>64</sup> For example, a more recent study from R. Frieden (2005)<sup>65</sup> strongly supports LLU and states: *"LLU can become an essential and effective vehicle for jumpstarting competition and for creating new incentives for speedier investment in next generation facilities and services."*
161. Regarding Batelco's point (d), TRA believes that Batelco's proposition to mandate Bitstream only and not LLU for the interim period during which broadband and NGN will develop is not appropriate as explained in paragraphs 48 to 66. In response to Batelco's statement that many initiatives are taking place and that these should be taken into account by TRA, TRA submits that each initiative responds to specific issues and is fully necessary. TRA is of the view that the market failures generated by Batelco's dominance in the wholesale broadband access market and in the wholesale physical network infrastructure access market needs to be considered immediately and requires remedies such as Bitstream and LLU. TRA is also of the view that there is no need to assess the many initiatives quoted by Batelco.
162. Regarding Batelco's point (e), TRA refers to its conclusions on Question 1 (paragraphs 52 to 64), where it explained that, given the fact that Batelco has no NGA plans at this stage, considering the time required to deploy NGA and given that Batelco's current Service Node locations will probably remain key network points in the future, TRA remains of the view that LLU is appropriate in the current context as well as in the context of NGN/NGA. Regarding the fact that LLU may constrain the development of NGN/NGA in Bahrain, TRA is of the view that, considering the current market failures identified in the broadband market and in the absence of any NGA plans from Batelco, TRA must act. Should Batelco have detailed NGA plans, TRA would welcome being

---

<sup>64</sup> Batelco also quotes another article from Spiller and Ulset ("Why Local Loop Unbundling Fails", December 2002). TRA is of the view that this article was published very early, before LLU was successful in many European countries. TRA therefore believes that this article is not relevant.

<sup>65</sup> R. Frieden, Unbundling the local loop: a cost/benefit analysis for developing nations, 2005

presented with these plans and would fully consider them in light of, for example, the approach to NGA of the regulator in the Netherlands, which considered the impact of NGA on LLU.<sup>66</sup>

163. Regarding Batelco's point (f), TRA disagrees with Batelco on the following points:

- a) Point (i) - Bitstream has strong growth in countries where it has been introduced. TRA has demonstrated above (see Figure 7) that LLU can also have a strong growth. The example of Cyprus where the number of LLU lines account for 20% of broadband lines at early 2009<sup>67</sup> is also relevant due to its similar size to Bahrain.
- b) Point (ii) - Bitstream is superior in residential markets. TRA has detailed in paragraph 62 why it disagrees with Batelco's view that Bitstream is superior in residential markets. Currently, in many European countries, such as France, Germany and the UK, LLU is superior to Bitstream in residential markets.
- c) Point (iii) - Bitstream has significantly lower churn-associated costs. While it is correct that one-off fees can be greater for LLU compared to Bitstream, TRA believes that such one-off fees generally comprise a small portion of LLU costs compared to the LLU monthly rental charge. For example, in the EU27 in late 2008 the average monthly rental charge was €9.28<sup>68</sup> and the average one-off charge (connection charge) was €57.54<sup>69</sup>, which means that, for a customer remaining with the same LLU operator for 24 months, connection charges represent only 20% of the total cost, and for a customer remaining 36 months, they represent 15%. This has to be put into perspective as LLU enables greater product differentiation and independence from the incumbent.
- d) Point (vii) - Bitstream is more suitable in smaller countries. TRA would like to stress that it does not simply copy the "bigger state" regulation. In defining the appropriate regulatory remedies for the wholesale broadband market and more generally its approach to regulation TRA takes into account the size of the Kingdom of Bahrain and applies the legal framework in place. Through its consultation documents, TRA explains and justifies in details its position. TRA also notes that the report on regulation in microstates extensively quoted by Batelco was produced by the consultants Ovum / Indepen on behalf of incumbent operators of three small European states and that it did not lead to regulatory changes.
- e) Point (viii) - Bitstream is superior in difficult economic times. Even if TRA naturally agrees that investment may be less easy in difficult economic times and that LLU requires more investment than Bitstream, TRA is of the view that it would be inappropriate not to mandate LLU for that reason. Despite the

---

<sup>66</sup> OPTA, "KPN's Next Generation Network: All-IP - Position paper, OPTA/BO/2006/202771", 3 October 2006.

<sup>67</sup> Source: ECTA

<sup>68</sup> *Commission Staff Working Document, Annex to the Communication from the Commission to the European Parliament, the Council, the European Economic and Social Committee and the Committee of the Regions Progress Report on the Single European Electronic Communications Market 2008 (14th report) {COM(2009) 140 final}*

<sup>69</sup> *Commission Staff Working Document, Annex to the Communication from the Commission to the European Parliament, the Council, the European Economic and Social Committee and the Committee of the Regions Progress Report on the Single European Electronic Communications Market 2008 (14th report) {COM(2009) 140 final}*

difficult economic times, three OLOs have expressed their interest in LLU. Further, the investment level required to start unbundling loops in a country like Bahrain with a limited number of Service Nodes is reasonable especially when compared to the deployment of an alternative local loop.

164. TRA agrees with Batelco that Bitstream has lower upfront costs and faster market entry times and may have lower service-provisioning delays compared to LLU. However, those relative advantages have to be balanced against the advantages of LLU (e.g. greater product differentiation, more diverse services, greater control of services, etc). The specific advantages of bitstream and LLU reinforce the fact that Bitstream and LLU are complementary products.
165. Having considered the views of the respondents, TRA remains of the view that it is no more than appropriate and necessary to address the market failure identified to impose upon Batelco an obligation to provide LLU.

## 5 Other comments from respondents

166. In addition to the answers to the questions asked by TRA to the industry in the March 2009 Study, one respondent, Batelco, expressed additional comments. These comments are considered hereafter.

### 5.1 Comments about TRA's change of approach

#### Comment from Batelco

167. Batelco observes that while TRA was of the view that Bitstream should be mandated but not LLU on 30 June 2004, on 22 January 2006 and in a study commenced in August 2007 and concluded in November 2007, TRA subsequently altered its policy on 28 February 2008. Batelco submits that TRA did not provide detailed explanations for this change and did not articulate why this change in policy was proportionate and reasonable, despite the shortcomings identified in the November 2007 report.

#### TRA analysis and conclusion

168. TRA disagrees with Batelco and considers that the introduction of LLU has been fully articulated and justified. TRA notes that in its 2007 "Statement on Local Loop Unbundling in Bahrain",<sup>70</sup> TRA chose a "wait and see approach" for LLU and stated that it would consider in particular the recommendations of the "Strategic Retail and Market Review":

*"TRA has at present decided to adopt a 'wait and see approach' relating to the possible implementation of ULL. In taking this approach TRA will take into account not only the findings of the Report but also:*

- *The final recommendations of the Strategic Retail and Market Review due in March 2008; and*
- *The outcome of the upcoming Reference Offer assessment cycle where Batelco will submit Service Descriptions including Terms and Conditions and wholesale tariffs for all access products."*

169. The 2008 "Strategic Retail and Market Review" has led TRA to consider that LLU should be introduced, in particular in view of the industry's comments and market developments.

170. The pros and the cons of introducing LLU as proposed in the 2008 "Strategic Retail and Market Review" have been fully considered in this Study in line with applicable legal requirements. Further TRA observes that countries such as New Zealand and Jordan, which initially did not mandate LLU, have subsequently decided to introduce LLU.

### 5.2 Comments about tariff rebalancing

#### Comment from Batelco

171. Batelco submits that, in the event that LLU is mandated, a process of rebalancing tariffs before introduction of LLU is vital. According to Batelco, having LLU in an environment with unbalanced tariffs will serve only to distort the market and hamper effective and efficient competition.

---

<sup>70</sup> TRA, "Statement on Local Loop Unbundling in Bahrain", 28 November 2007.

172. Batelco submits that unbalanced tariffs have posed a problem for liberalising countries around the world.
173. Batelco is of the view that balanced tariffs are critical in determining an appropriate costing methodology for LLU and that it is difficult, if not impossible, to determine a costing methodology for LLU without first working out the costing and rebalancing of retail calls. Batelco takes the Dutch example, where LLU pricing was initially based on historic costs but then moved to current costs as the initial costing methodology was failing to encourage efficient and effective competition.
174. Batelco finally adds that it has not found any other jurisdiction that introduced LLU before it rebalanced its tariffs.

### **TRA analysis and conclusion**

175. On the subject of tariff rebalancing, TRA notes, firstly, that it has recently published a consultation document on tariff rebalancing.<sup>71</sup>
176. TRA is of the view that an environment where tariffs are not balanced leads to incorrect price signals for market entry, investment and the development of competition. Ultimately this may be damaging for the long-term interest of end-users. This is why TRA has engaged in such a process.
177. However, TRA believes that this should not prevent wholesale products from being proposed by Batelco. TRA disagrees with Batelco's view that balanced tariffs are critical in determining an appropriate pricing methodology for LLU. TRA is indeed of the view that, as explained in its report on the appropriate approach for LLU implementation,<sup>72</sup> LLU prices should be cost-oriented. As a consequence, LLU prices will be estimated on the basis of benchmarking or top-down information or bottom-up information but not on the basis of retail prices. This means that the pricing of LLU can be done independently of the process of tariff rebalancing.
178. TRA finally points out that the Dutch example is not related to the issue of tariff rebalancing: many NRAs are changing or have changed their methodologies for pricing LLU between top-down historic costs, top-down current costs, bottom-up LRIC, etc. without these choices being related to the issue of tariff rebalancing but mainly related to the nature of price signals that NRAs want to send to the market.
179. TRA also observes that in 2003 Belgium, Luxembourg, Portugal and Sweden had not rebalanced their tariffs<sup>73</sup> but LLU was implemented.<sup>74</sup>
180. Overall, TRA is of the view that the issue of tariff rebalancing does not prevent LLU from being mandated. The issue of tariff balancing can be dealt with separately.

---

<sup>71</sup> See TRA, "Rebalancing for Fixed Services and Price Monitoring: Draft Statement", 9 June 2009, LAU/0509/123.

<sup>72</sup> See Annex B of the Access Order, "Implementation Report for Local Loop Unbundling (LLU) in the Kingdom of Bahrain", 14 September 2009.

<sup>73</sup> See [http://ec.europa.eu/information\\_society/policy/ecom/doc/library/annualreports/9threport/annex2181103.pdf](http://ec.europa.eu/information_society/policy/ecom/doc/library/annualreports/9threport/annex2181103.pdf) pages 5 and 6.

<sup>74</sup> See [http://ec.europa.eu/information\\_society/policy/ecom/doc/library/annualreports/9threport/annex1191103.pdf](http://ec.europa.eu/information_society/policy/ecom/doc/library/annualreports/9threport/annex1191103.pdf) page 48.

# Annex A: Benchmarks of Retail Broadband Offers

- 181. This benchmark looks at four areas (EU15, GCC, selected Arab countries and selected smaller states). In each area two metrics are analysed:
  - retail prices;
  - maximum download speed offered.

182. As 2 Mbps is a standard offer in Europe, prices have been compared for this type of broadband offer.

### EU15

183. For 2 Mbps offers, Batelco’s broadband retail prices are far higher than prices available in Europe, where the average of the EU15 is only BD 15 compared to BD 60 for Batelco.

**Figure 9 - Broadband monthly residential prices, VAT included, 2007**



*Source: Development of Broadband Access in Europe, Idate, October 2007*

184. In addition, the maximum download speed offered in Europe is almost ten times higher than Batelco’s, which stands at only 2 Mbps.

**Figure 10 - Maximum download speed offered, 2007**

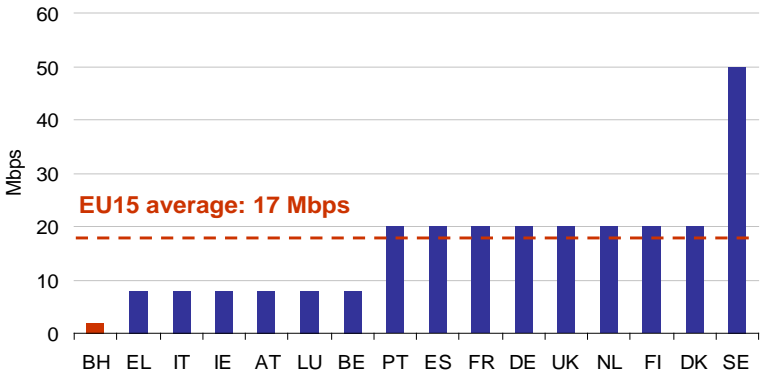

*Source: Development of Broadband Access in Europe, Idate, October 2007*

GCC (comparison between incumbents' offers)

185. Whereas 256 kbps residential offers in Bahrain are the cheapest, 2 Mbps offers are not in a good position compared to other GCC countries.

**Figure 11 - Broadband residential prices, VAT included (for 256 kbps and 2 Mbps), 2008**

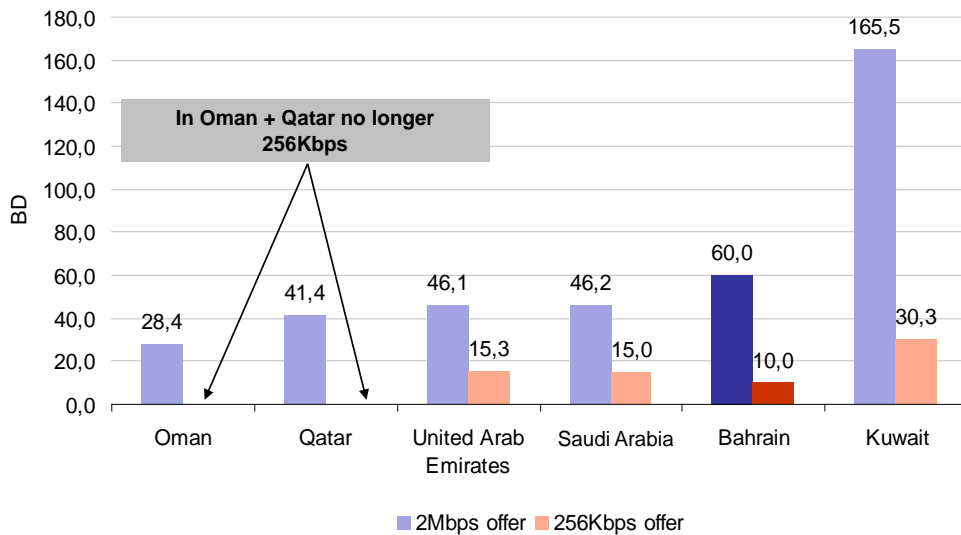

**Source: Operators' websites, November 2008**

When updating the data (see figure below), it appears that 256 kbps residential offers in Bahrain are still the cheapest and 2 Mbps are now in the average of GCC countries.

**Figure 12 - Broadband residential prices, VAT included (for 256 kbps and 2 Mbps), 2009**

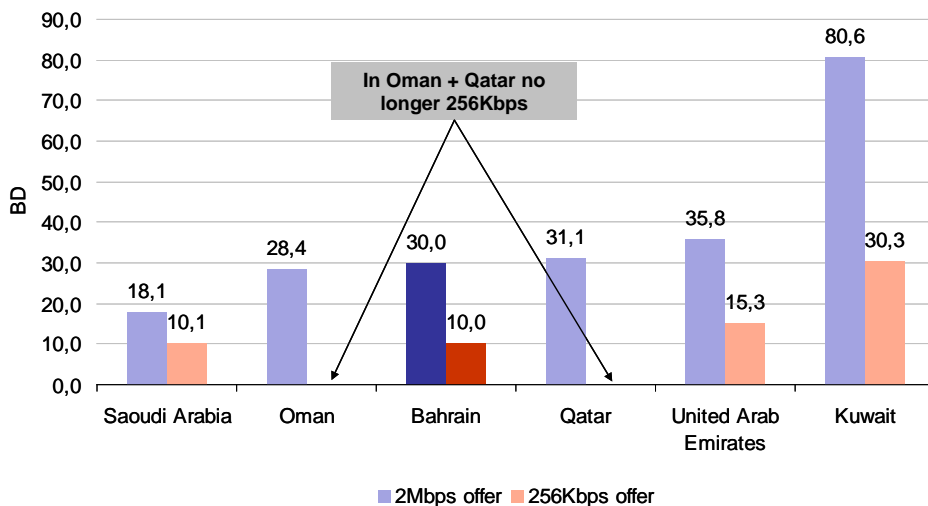

**Source: Operators' websites, August 2009**

186. The Bahraini maximum download speed is far below that available in Saudi Arabia, which is 20 Mbps. Recent reports also suggest that Etisalat may shortly introduce triple play services in partnership with FT in the UAE.

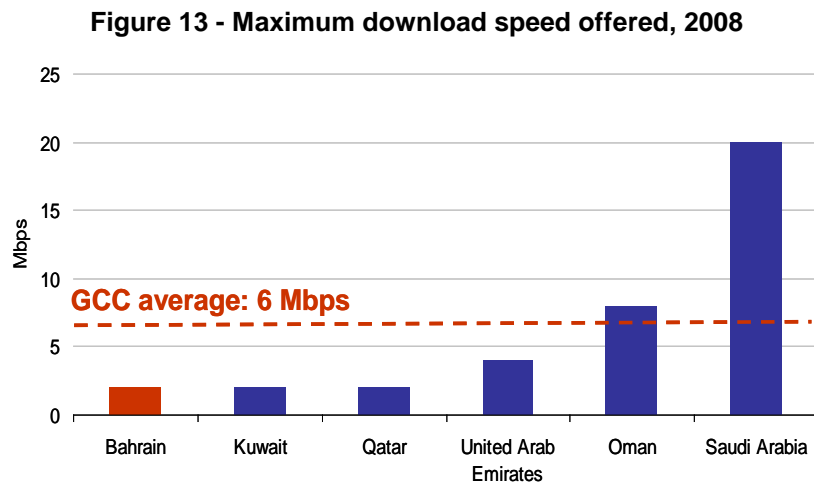

*Source: Operators' websites, November 2008*

When updating the data (see in figure below), it appears that, since the maximum download speed offered has become 10Mbps in Bahrain in August 2009, the position of Bahrain has improved, though significantly below Saudi Arabia, which is 20 Mbps and other more advanced countries.

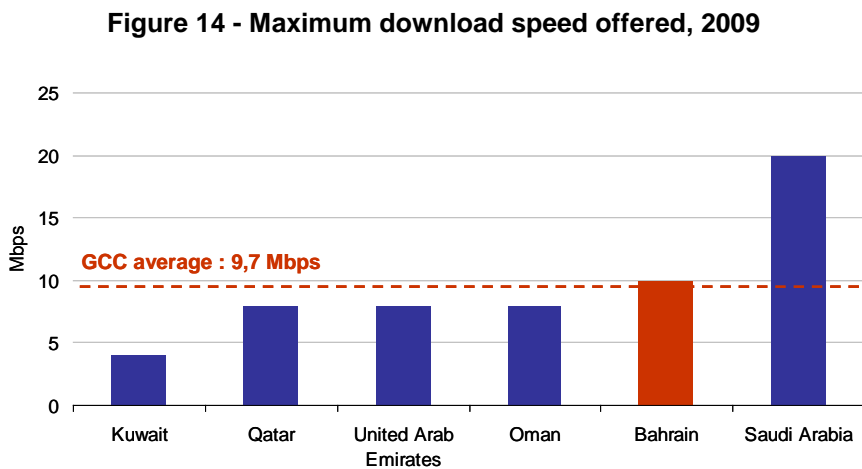

*Source: Operators' websites, August 2009*

*Selected Arab countries (comparison between incumbents' offers)*

187. The price comparison for 2 Mbps offers shows that Bahrain is the most expensive country for residential subscribers.

**Figure 15 - Broadband residential prices, VAT included (for 2 Mbps), 2008**

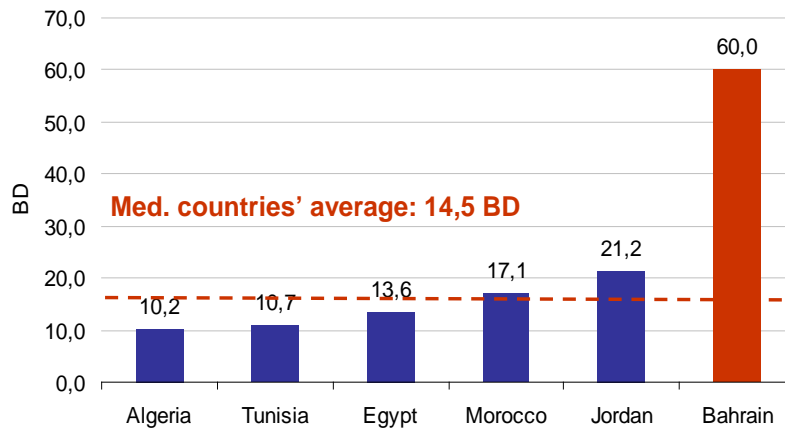

**Source: Operators' websites, November 2008**

When updating the data (see figure below), it appears that, even if prices in Bahrain has declined significantly since last year, Bahrain remains the most expensive country for residential subscribers in 2009.

**Figure 16 - Broadband residential prices, VAT included (for 2 Mbps), 2009**

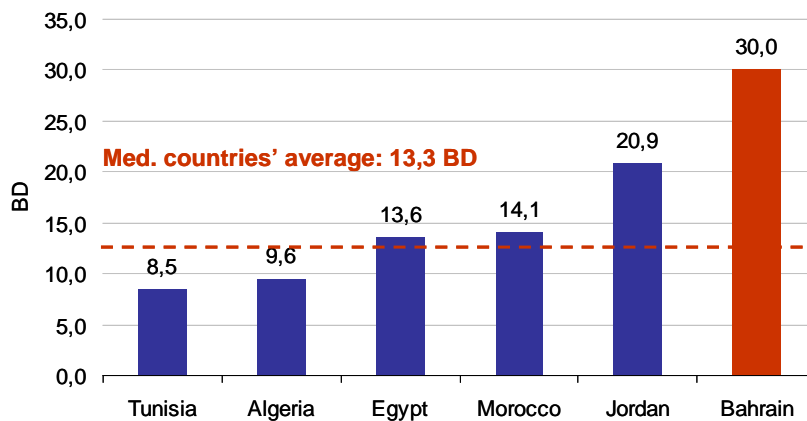

**Source: Operators' websites, August 2009**

188. Morocco already has broadband offers of up to 20 Mbps and triple play, although most residential users are still on 256 kbps offers).

**Figure 17 - Maximum download speed offered, 2008**

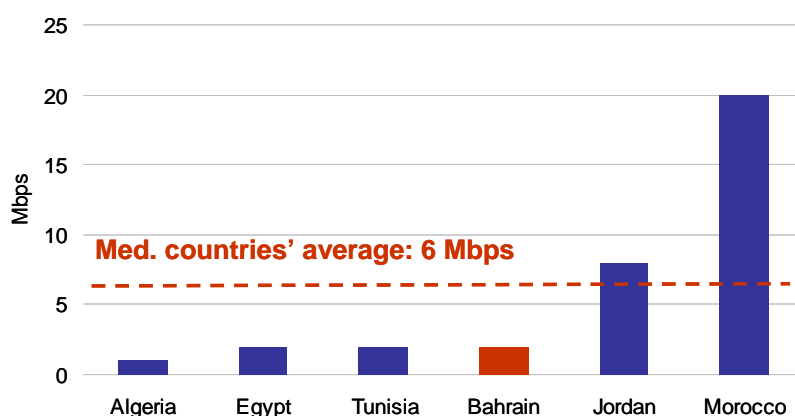

*Source: Operators' websites, November 2008*

When updating the data (see figure below), it appears that, since the maximum download speed offered has become 10Mbps in Bahrain in August 2009, it has improved its position, although the available speed remain significantly below Morocco, which is 20 Mbps.

**Figure 18 - Maximum download speed offered, 2009**

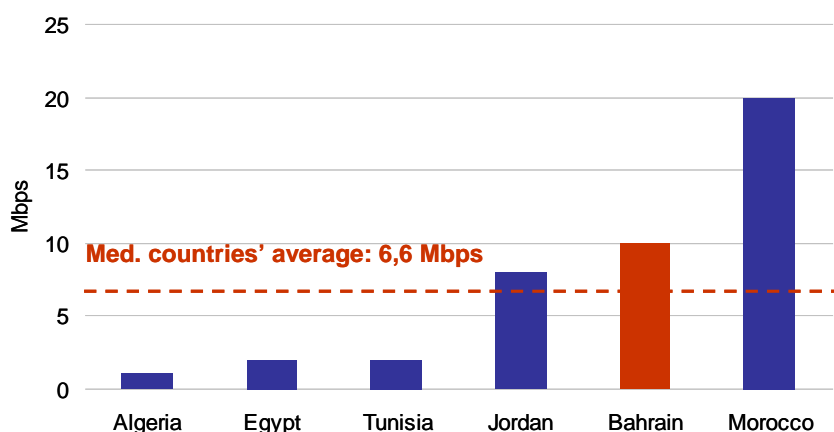

*Source: Operators' websites, August 2009*

*Smaller states (comparison between incumbents' offers)*

189. Among smaller states, Bahrain is again the most expensive country, whether for residential or for business customers.

**Figure 19 - Broadband residential prices, VAT included (for 2 Mbps), 2008**

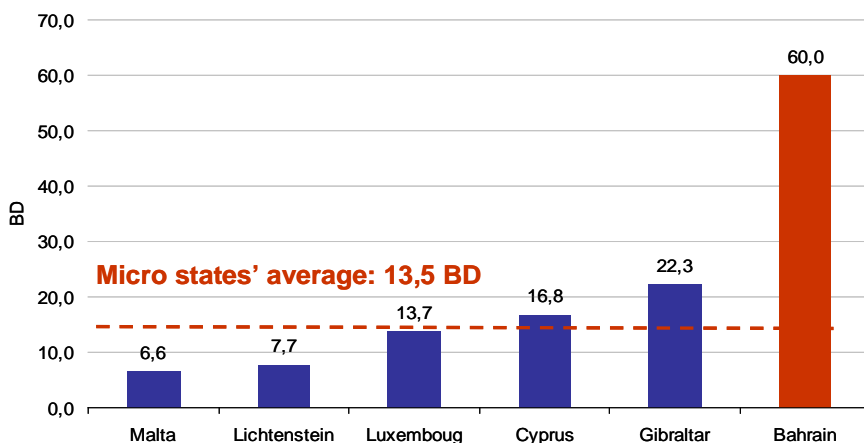

*Source: Operators' websites, November 2008*

When updating the data (see figure below), it appears that, even if prices in Bahrain has declined significantly last year, Bahrain remains the most expensive country for residential subscribers in 2009.

**Figure 20 - Broadband residential prices, VAT included (for 2 Mbps), 2009**

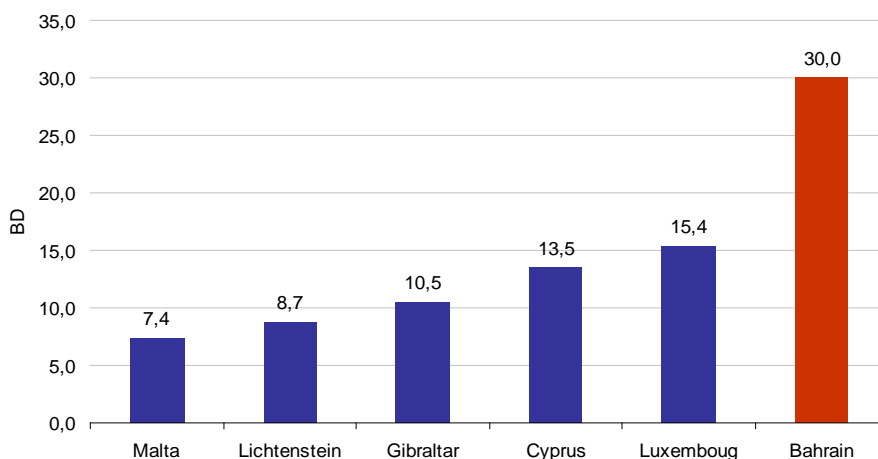

*Source: Operators' websites, August 2009*

190. Bahrain also has one of the lowest levels of maximum download speed, providing only 2 Mbps.

**Figure 21 - Maximum download speed offered, 2008**

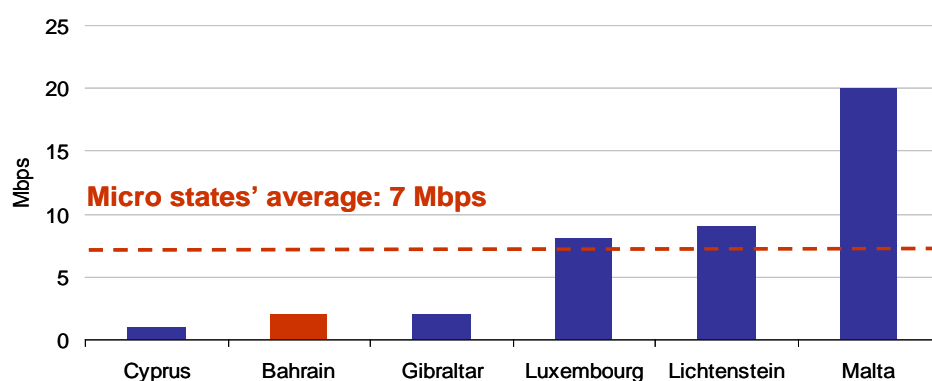

*Source: Operators' websites, November 2008*

When updating the data (see figure below), it appears that, since the maximum download speed offered has become 10Mbps in Bahrain in August 2009, it has improved its position, although it remains significantly below Malta, which is 20 Mbps.

**Figure 22 - Maximum download speed offered, 2009**

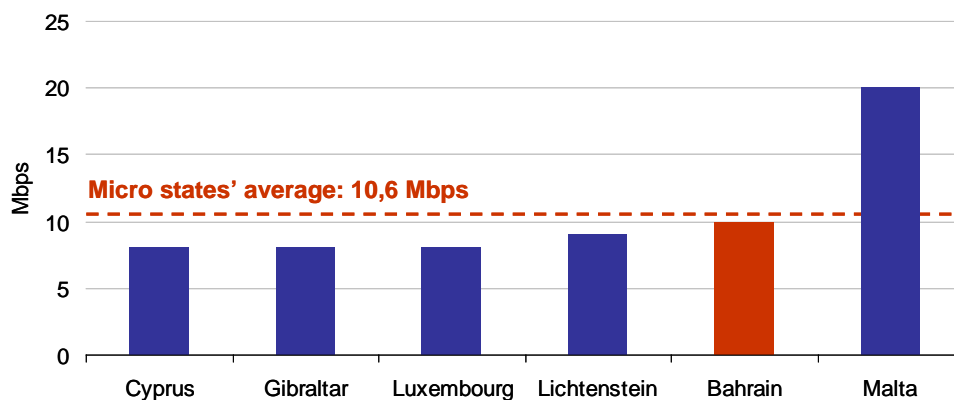

*Source: Operators' websites, August 2009*

## Annex B: Domestic Benchmarks of Retail Broadband Offers

191. The Figures below show that, whichever the download speed, the latest Wimax offers from Mena Telecom have lower prices than those using DSL technology (approximately 50% for all download speeds).

**Figure 23 - Price of residential offers, November 2008**

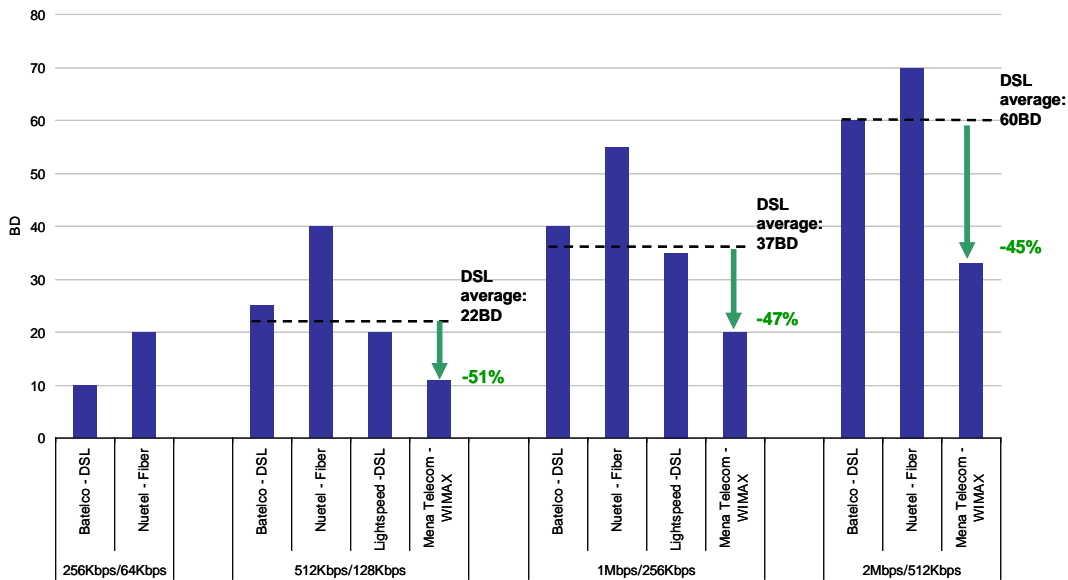

*Source: Operators' websites, November 2008*

When updating the data (see in figure below), the analysis remains unchanged. Although, the gap in prices between the latest Wimax offers from Mena Telecom and those using DSL technology has narrowed for offers up to 4 Mbps, Wimax offers are significantly more expensive than DSL based offers for higher speed offers.

**Figure 24 - Price of residential offers, August 2009**

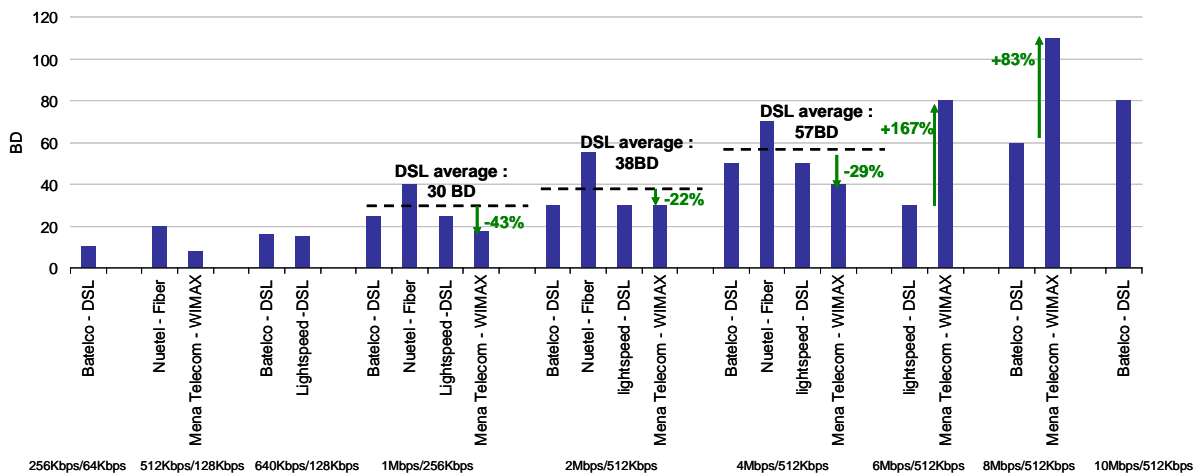

*Source: Operators' websites, August 2009*

192. Contrary to prices, the threshold is at a much lower level with Wimax than for operators using DSL technology (approximately 60% less for Wimax). Wimax subscribers are much more rapidly throttled, at a download speed of 128 kbps.

**Figure 25 - Threshold of residential offers, November 2008**

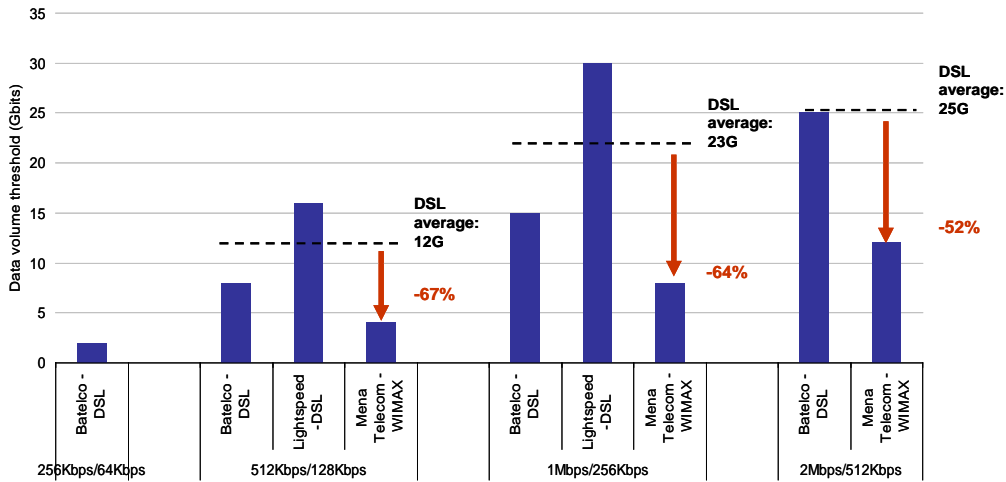

*Source: Operators' websites, November 2008*

When updating the data (see figure below), it appears that Wimax based offers are now available with a higher threshold (though also at a higher price than comparable DSL base offers).

**Figure 26 - Threshold of residential offers, August 2009**

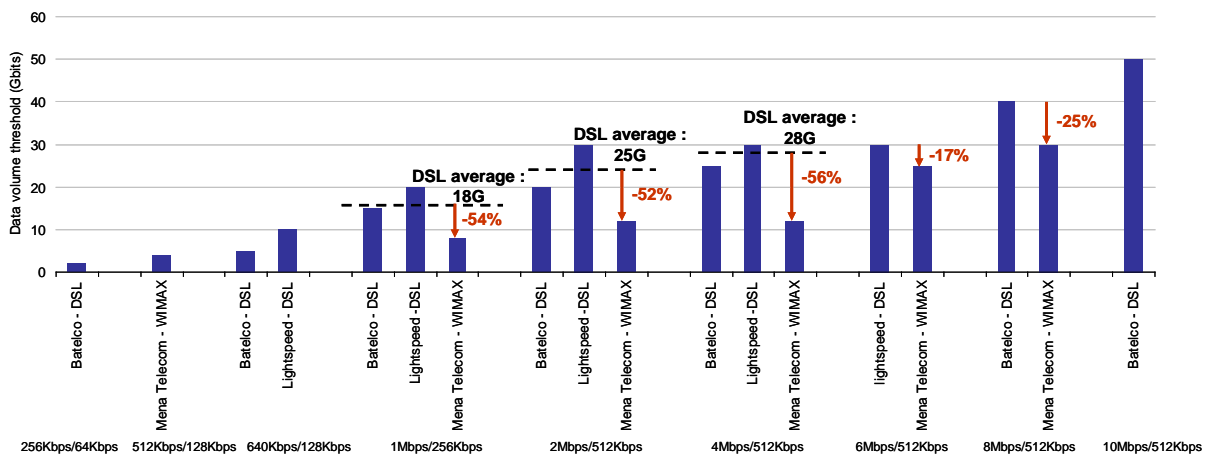

*Source: Operators' websites, August 2009*

## **Annex C: LLU and Bitstream chronology in some smaller countries**

### **Bahrain**

193. January 2006: TRA assesses the dominant position of Batelco in the relevant wholesale market: TRA required Batelco to provide TRA with a Reference Access Offer (RAO) for approval, within two months from the date of this Determination (source: TRA, "Dominance in Wholesale Markets by Batelco", 22 January 2006).
194. June 2007: launch of Bitstream access offers by Batelco to alternative operators (source: TRA annual report, p. 27).
195. March 2009: TRA submits a consultation on Local Loop Unbundling (source: TRA, "Appropriate Approach for of Local Loop Unbundling (LLU) in the Kingdom of Bahrain", 26 March 2009).
196. The final determination is issued by TRA on the way to implement LLU in September 2009.

### **New Zealand**

197. May 2004: the Minister of Communication announces its decision to accept the Commission's recommendation to regulate UBS (i.e. bitstream) instead of LLU (source: [http://www.ispanz.org.nz/pdf/ISPANZ\\_position\\_paper-UBS.pdf](http://www.ispanz.org.nz/pdf/ISPANZ_position_paper-UBS.pdf)).
198. March 2005: the incumbent, Telecom, launches residential 1 Mbps and 2 Mbps UBS products (source: [http://www.ispanz.org.nz/pdf/ISPANZ\\_position\\_paper-UBS.pdf](http://www.ispanz.org.nz/pdf/ISPANZ_position_paper-UBS.pdf)).
199. May 2006: the Government initiates a review of the Telecommunications Act and considers unbundling the local loop (source: <http://www.bellgully.com/resources/resource.00625.asp>).
200. December 2006: the revised legislation mandating local loop unbundling comes into force
201. In November 2007 the Commerce Commission issues the final standard terms determination (source: Commerce Commission, Decision 609, 7 November 2007).

### **Jordan**

202. May 2005: TRC issues a determination that imposed Bitstream access services on the incumbent (source: TRC, "Interconnection Instructions", 1 May 2005).
203. May 2008: TRC requests comments from the industry on the implementation of Local Loop Unbundling in Jordan (source: TRC, "Notice Requesting Comments on the Implementation of Local Loop Unbundling, Collocation and Infrastructure Sharing in Jordan", May 2008).

**Figure 27 - Comparison between Bahrain, Jordan and New Zealand for LLU and Bitstream implementation**

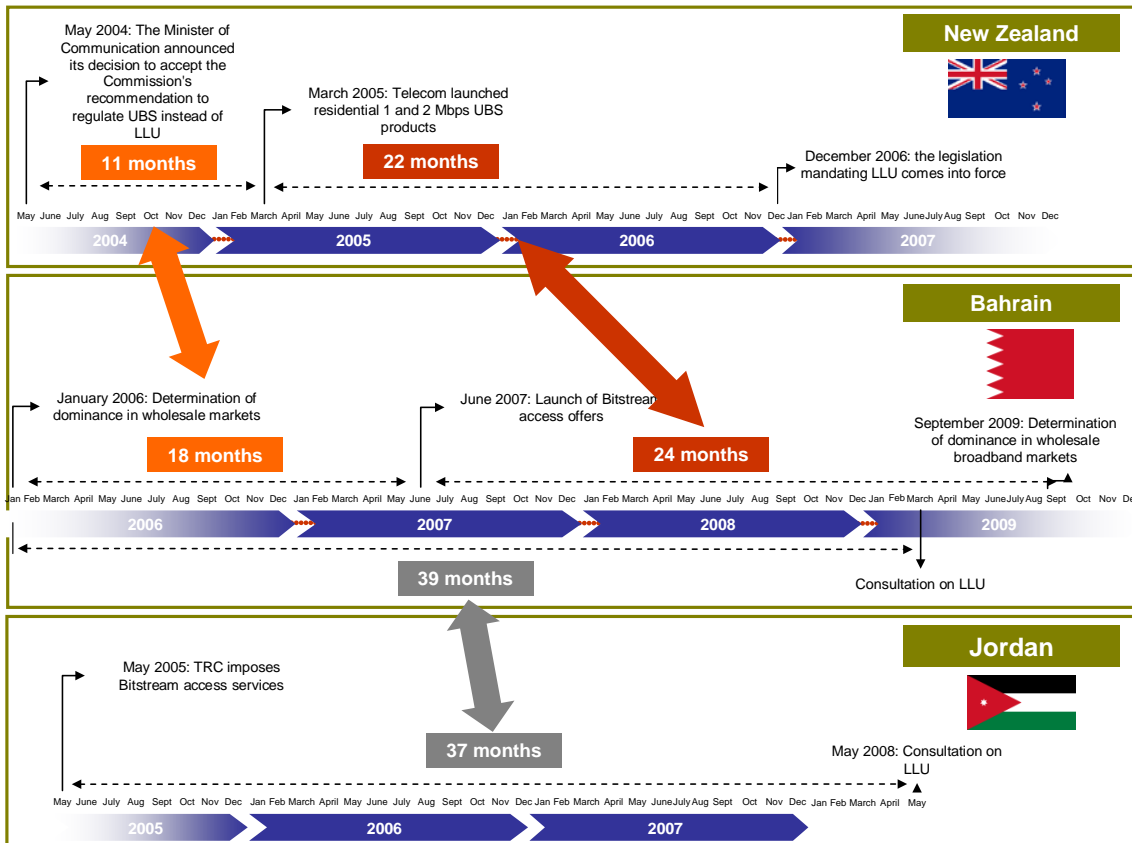

## Cyprus

204. 2005: two agreements are signed by alternative operators with Cyta, the incumbent, on Local Loop Unbundling (source: Cyta, Annual Report, 2005).
205. 2006: the incumbent publishes its first Bitstream access Reference Offer (Source: Cyta, Annual Report, 2006).

## Slovenia

206. The ATRP further liberalises the market with Local Loop Unbundling (source: Telekom Slovenije, Annual Report, 2003, p. 4).
207. Since 2003, both LLU and bitstream are available for OLOs (source: Telekom Slovenije, Annual Report, 2003, p. 29)

**An Access Order Relating Local Loop Unbundling, Bitstream  
and Wholesale DSL issued pursuant to the Access Regulation**

**Annex D**

**Legal Reasoning**

**An Access Order Relating Local Loop Unbundling, Bitstream and Wholesale DSL issued pursuant to the Access Regulation**

Article 3(c)(1) of the Telecommunications Law grants TRA the power to issue regulations, orders and determinations as may be necessary for the implementation of the Telecommunications Law, including and in particular regulations, orders and determinations in relation to Interconnection, Access to networks and facilities, services tariffs, access to property and the promotion of competition;

Article 3(c)(13) of the Telecommunications Law grants TRA the power to encourage, regulate and facilitate adequate access and interconnection arrangements, including, where necessary, enforcing the sharing by public telecommunications operators of the benefits of facilities and property;

Pursuant to the obligations provided in Article 57(e) of the Telecommunications Law, upon request, a Dominant Operator shall offer access to its Telecommunications Network and Telecommunications Facilities on fair and reasonable terms to any Licensed Operator.

Pursuant to the Access Regulation, TRA may impose certain Access Obligations, as described in its Articles 3.3., 3.4 and 3.5 of the Access Regulation, on a Licensed Operator with a Dominant Position in the relevant market ("Dominant Operator") by way of an Access Order issued in accordance with Article 2 and Article 3(c)(1) of the Telecommunications Law.

In accordance with the above TRA has issued:

- (b) A Dominance Determination in Wholesale Broadband Markets dated [please insert the date] ("Dominance Determination") which defined the relevant markets and determined that Batelco is dominant in the Wholesale Physical Network Infrastructure Access Market and in the Wholesale Broadband Access Market;
- (c) An Access Order for Batelco to implement Full LLU in the Kingdom of Bahrain having the following Schedules attached to it:
  - i. A Study on the Regulation of Wholesale Broadband Markets dated [please insert the date] ("Study") determining appropriate wholesale remedies which are Wholesale DSL (Article 3.5 (d)), unbundled local loops (Article 3.5 (e)) and main distribution frames or concentrators for Bitstream access or DSL co-location (Article 3.5 (f)), to address the market failures identified by TRA in the Dominance Determination. The Study explains why Batelco should continue to provide Bitstream and Wholesale DSL and why TRA considers it no more than appropriate and necessary to address the market failure identified to impose upon Batelco to provide LLU for the purpose of Article 3.7 of the Access Regulation; and
  - ii. An Implementation Report setting out the appropriate approach for the implementation of LLU in the Kingdom of Bahrain [please insert the date].

Based upon this, in accordance with Article 2.1 of the Access Regulation and the Dominance Determination, TRA orders Batelco to provide LLU, Bitstream and Wholesale DSL services as Access Obligations under this Access Order.

Article 3.4 of the Access Regulation allows TRA to require the Dominant Operator to give other Licensed Operators access to specified elements of either or both of its Telecommunications Network and Telecommunications Facilities.

**An Access Order Relating Local Loop Unbundling, Bitstream and Wholesale DSL issued pursuant to the Access Regulation**

Article 3.5 of the Access Regulation lists certain specific elements, including Wholesale DSL, unbundled local loops (LLU) and main distribution frames or concentrators for Bitstream access or DSL co-location.<sup>2</sup>

In accordance with the Dominance Determination, TRA considers that LLU is included in the relevant market for Wholesale Physical Network Infrastructure Access Market and that Wholesale DSL and Bitstream are included in the relevant Wholesale Broadband Access Market. As Batelco is found dominant in these two relevant markets, all three of these telecommunications network elements or telecommunications facilities specified in Article 3.5 (d), (e) and (f) of the Access Regulation may be imposed upon Batelco as the Dominant Operator.

Batelco already offers Wholesale DSL and Bitstream access to OLOs in the Kingdom of Bahrain, but not LLU. When considering whether to impose an Access Obligation to provide an Access Service, Article 3.7 of the Access Regulation requires the TRA to determine that the specific Access Obligation is no more than is appropriate and necessary, taking into account a number of criteria listed there.

On the basis of the Study conducted by TRA in accordance with Article 3.7 of the Access Obligation, TRA has:

- (a) considered the appropriate remedies with respect to wholesale services in the wholesale broadband markets; and
- (b) assessed whether it is no more than appropriate and necessary to impose upon Batelco an Access Obligation to address the market failure.

As a result, TRA can order Batelco to implement LLU by offering dedicated point to point Metallic Path Facility, providing physical connectivity between Batelco's Main Distribution Frame at Batelco's Service Node and Batelco's Network Termination Point at the End User's premises and to continue providing Bitstream and Wholesale DSL Services.

---

<sup>7</sup>. Articles 3.5 (d), (e) and (f) of the Access Regulation, respectively.